

ADJUSTABLE LOW DROPOUT VOLTAGE REGULATOR

■ GENERAL DESCRIPTION

The NJM2887 is an adjustable low dropout voltage regulator with ON/OFF control.

Advanced Bipolar technology achieves low noise, high ripple rejection and low quiescent current.

It is suitable for DVD, FAX and Car Audio.

■ PACKAGE OUTLINE

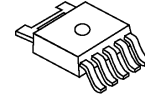

NJM2887DL3

■ FEATURES

- High Ripple Rejection 70dB typ. (f=1kHz,Vo=3V Version)
- Output Noise Voltage Vno=50μVrms typ.
- Output capacitor with 2.2μF ceramic capacitor
- Output Current Io(max.)=500mA
- High Precision Output Vref=1.29V±1.0%
- Low Dropout Voltage 0.18V typ. (Io=300mA)
- ON/OFF Control
- Internal Short Circuit Current Limit
- Internal Thermal Overload Protection
- Bipolar Technology
- Package Outline TO-252-5(DL3)

■ PIN CONFIGURATION

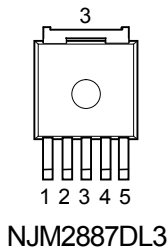

- PIN FUNCTION**
1. CONTROL
 2. V_{IN}
 3. GND
 4. V_{OUT}
 5. V_{ADJ}

NJM2887DL3

■ BLOCK DIAGRAM

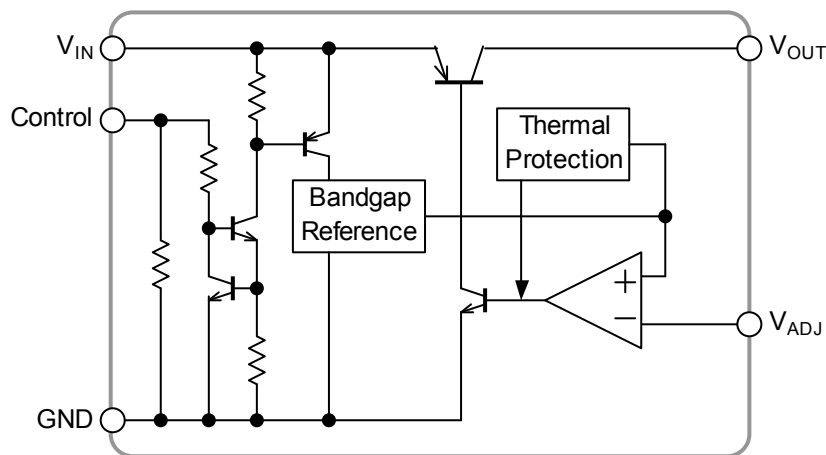

NJM2887

■ ABSOLUTE MAXIMUM RATINGS

(Ta=25°C)

PARAMETER	SYMBOL	RATINGS	UNIT
Input Voltage	V _{IN}	+14	V
Control Voltage	V _{CONT}	+14(*1)	V
Output Adjust Voltage	V _{ADJ}	+4	V
Power Dissipation	P _D	950(*2) 2500(*3)	mW
Operating Temperature	Topr	-40 ~ +85	°C
Storage Temperature	Tstg	-40 ~ +125	°C

(*1): When input voltage is less than +14V, the absolute maximum control voltage is equal to the input voltage.

(*2): Mounted on glass epoxy board. (76.2×114.3×1.6mm: based on EIA/JEDEC standard size, 2Layers, Cu area 100mm²)

(*3): Mounted on glass epoxy board. (76.2×114.3×1.6mm: based on EIA/JEDEC standard, 4Layers)

(For 4Layers: Applying 74.2×74.2mm inner Cu area and a thermal via hole to a board based on JEDEC standard JESD51-5)

■ Operating Voltage Range

$$V_{IN}=+2.3V \sim +14.0V$$

■ ELECTRICAL CHARACTERISTICS

(Unless otherwise noted, V_{IN}=Vo+1V, R1=100kΩ, C_{IN}=0.33μF, Co=2.2μF:Vo (Co=4.7μF: Vo≤2.6V), Ta=25°C)

PARAMETER	SYMBOL	TEST CONDITION	MIN.	TYP.	MAX.	UNIT
Output Voltage	Vo	Io=30mA	1.5	-	6	V
Reference Voltage	Vref	Io=30mA	1.277	1.29	1.303	V
Quiescent Current	I _Q	Io=0mA, Vo=3.0V	-	200	300	μA
Quiescent Current at Control OFF	I _{Q(OFF)}	V _{CONT} =0V	-	-	100	nA
Output Current	Io	Vo=0.3V	500	650	-	mA
Line Regulation	ΔVo/ΔV _{IN}	V _{IN} =Vo+1V ~ Vo+6.0V, Io=30mA	-	-	0.10	%/V
Load Regulation	ΔVo/ΔIo	Io=0 ~ 500mA	-	-	0.03	%/mA
Dropout Voltage(*4)	ΔV _{LO}	Io=300mA	-	0.18	0.28	V
Ripple Rejection	RR	ein=200mVrms, f=1kHz, Io=10mA Vo=3.0V Version	-	70	-	dB
Average Temperature Coefficient of Output Voltage	ΔVo/ΔTa	Ta=0~85°C, Io=10mA	-	±50	-	ppm/°C
Output Noise Voltage	V _{NO}	f=10Hz~80kHz, Io=10mA, Vo=3.0V Version	-	50	-	μVrms
Control Voltage for ON-state	V _{CONT(ON)}		1.6	-	-	V
Control Voltage for OFF-state	V _{CONT(OFF)}		-	-	0.6	V

(*4): Except output voltage less than 2.1V.

POWER DISSIPATION VS. AMBIENT TEMPERATURE

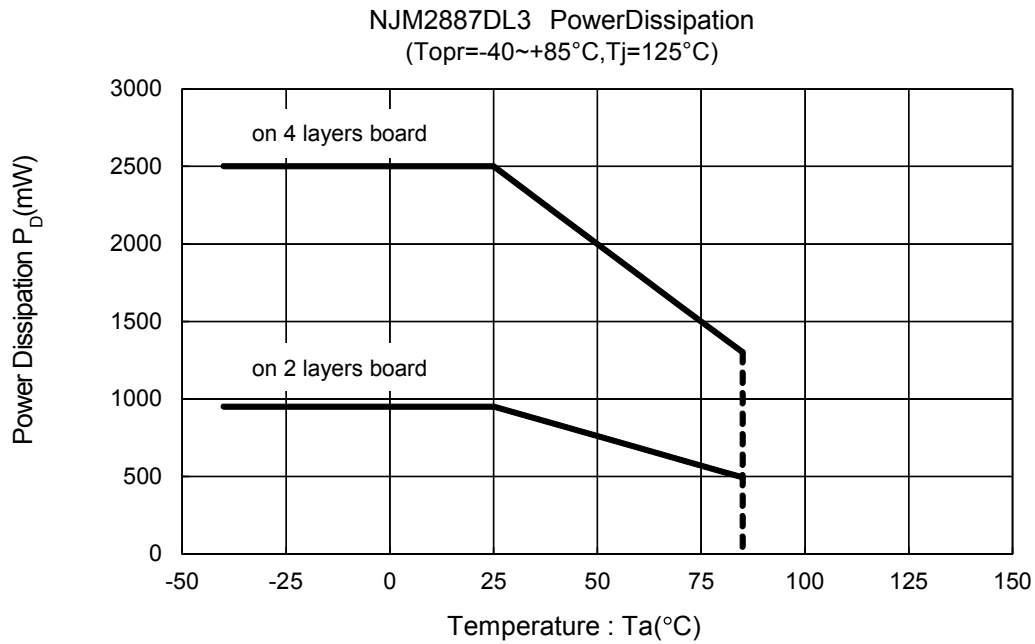

TEST CIRCUIT

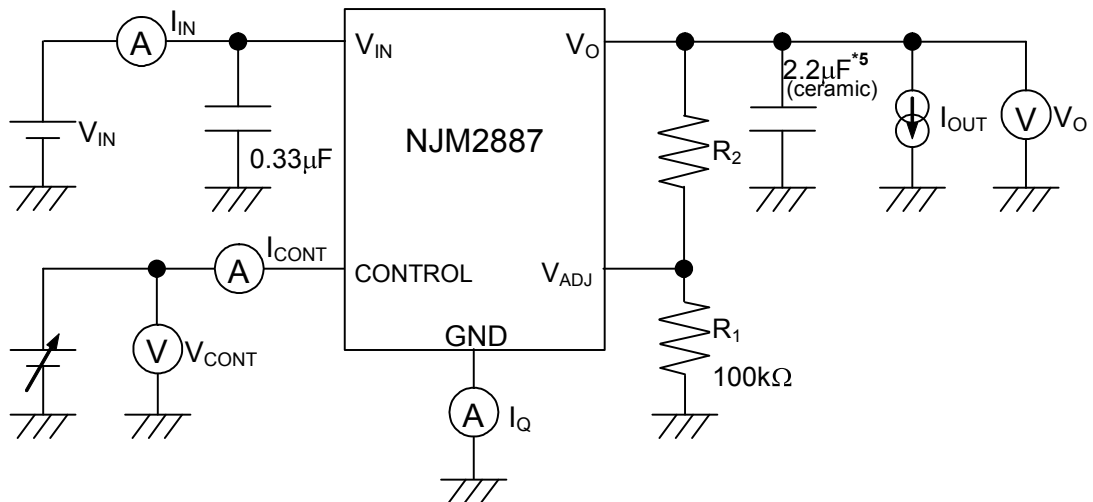

*5 $V_o \leq 2.6\text{V}$ version: $C_o = 4.7\mu\text{F}$ (ceramic)

$$V_o = V_{ref} \times (1 + R_2 / R_1)$$

The ceramic capacitor used by the output recommend the B characteristic.

NJM2887

TYPICAL APPLICATION

① In the case where ON/OFF Control is not required:

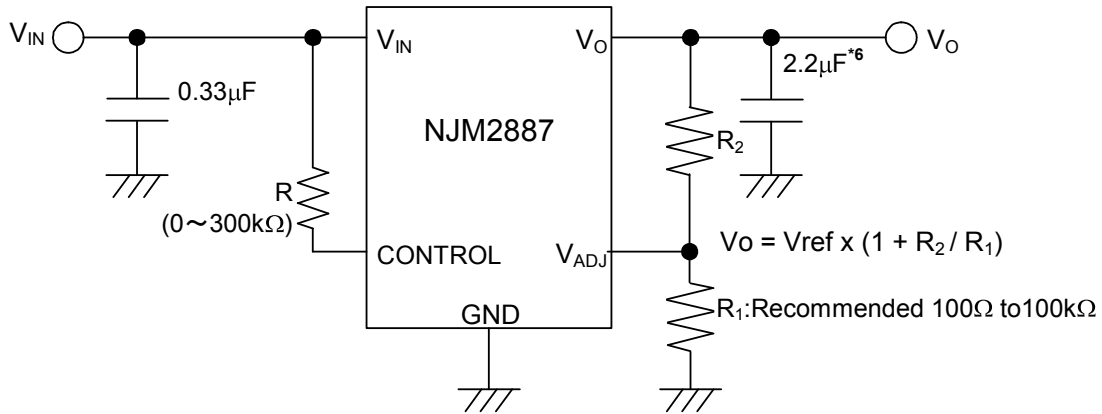

*6 $V_o \leq 2.6V$ version: $C_o = 4.7\mu F$

Connect control terminal to V_{IN} pin

② In use of ON/OFF CONTROL:

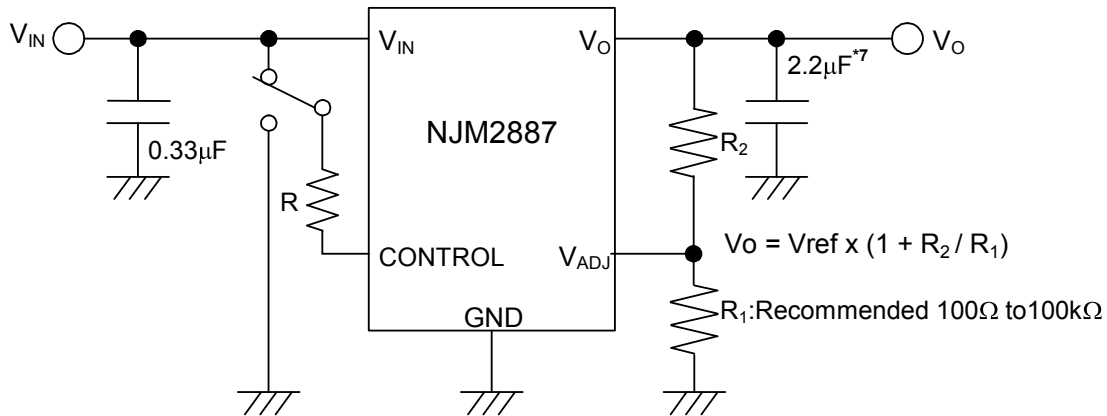

*7 $V_o \leq 2.6V$ version: $C_o = 4.7\mu F$

State of control pin:

- "H" → output is enabled.
- "L" or "open" → output is disabled.

*In the case of using a resistor "R" between V_{IN} and control.

The current flow into the control pin while the IC is ON state (I_{CONT}) can be reduced when a pull up resistor "R" is inserted between V_{IN} and the control pin.

The minimum control voltage for ON state ($V_{CONT(ON)}$) is increased due to the voltage drop caused by I_{CONT} and the resistor "R". The I_{CONT} is temperature dependence as shown in the "Control Current vs. Temperature" characteristics. Therefore, the resistor "R" should be carefully selected to ensure the control voltage exceeds the $V_{CONT(ON)}$ over the required temperature range.

*Feedback Resistor "R1".

The range of feedback resistor "R1" is recommended from 100Ω to 100kΩ.

When the value of feedback resistor "R1" is large, the output voltage may rise higher than the setting output voltage by leak current from V_{OUT} at high temperature.

On the other hand, a smaller feedback resistor may increase output noise voltage and quiescent current.

Regarding to reduce output noise voltage, refer to next article in addition.

③ Reduction of output noise voltage:

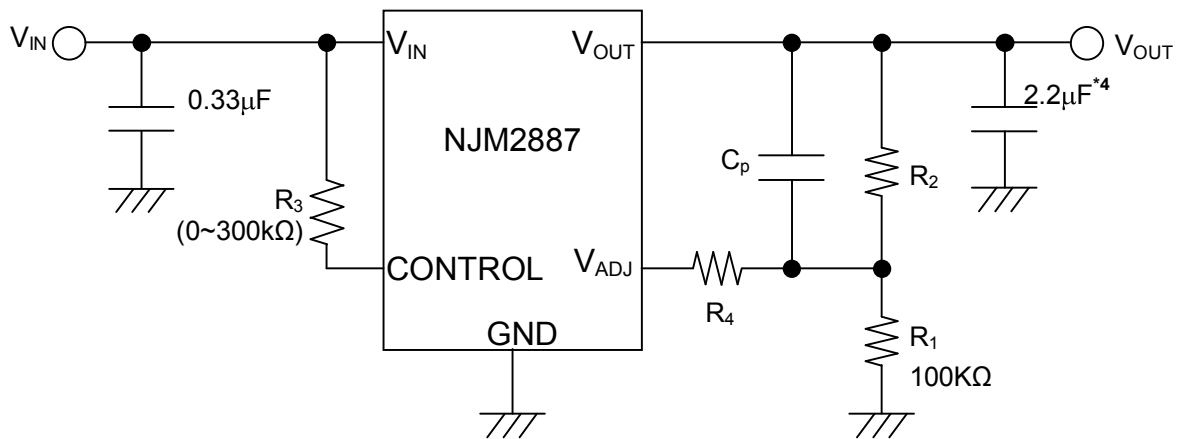

*4 $V_o \leq 2.6V$ version: $C_o = 4.7\mu F$

Output feedback resistance: R_1 , should connect near V_{ADJ} terminal.

For reduce output noise voltage, connect C_p and R_4 refer to the following table.

The example of use of C_p and R_4

Output capacity value	$R_1 = 10k\Omega$	$R_1 = 1k\Omega$	$R_1 = 100\Omega$	R_4
$C_o = 2.2\mu F$	$C_p = 100pF$	$C_p = 1nF$	$C_p = 0.01\mu F$	10kΩ or less
$C_o = 4.7\mu F$	$C_p = 680pF$	$C_p = 6.8nF$	$C_p = 0.068\mu F$	

NJM2887

ELECTRICAL CHARACTERISTICS

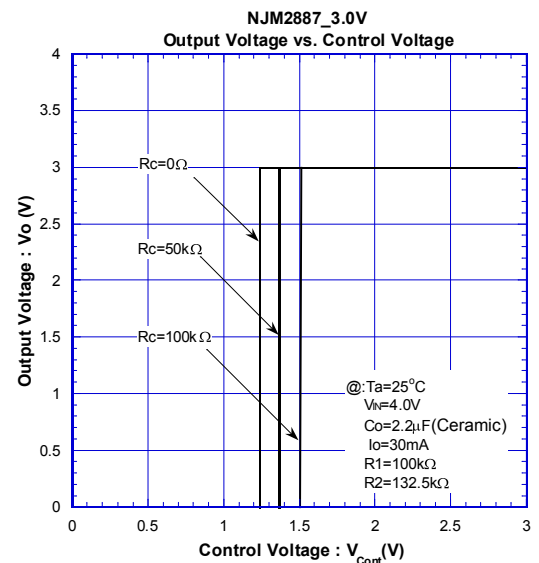
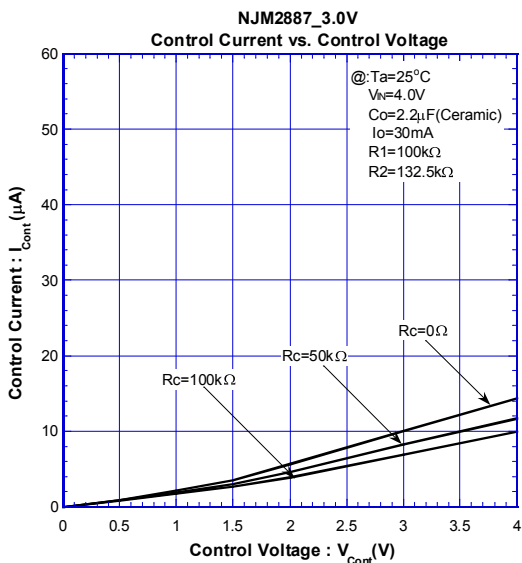
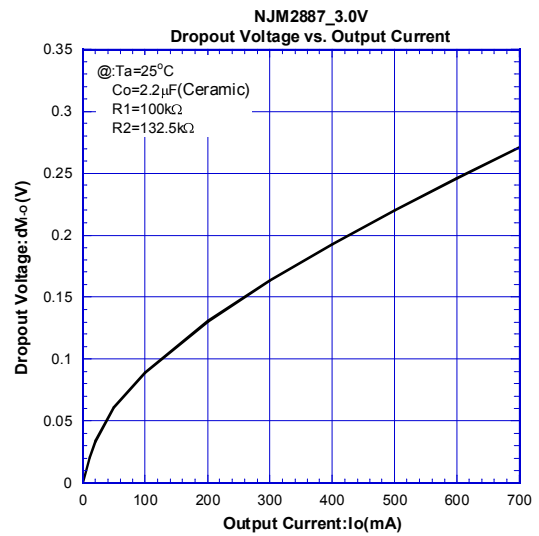
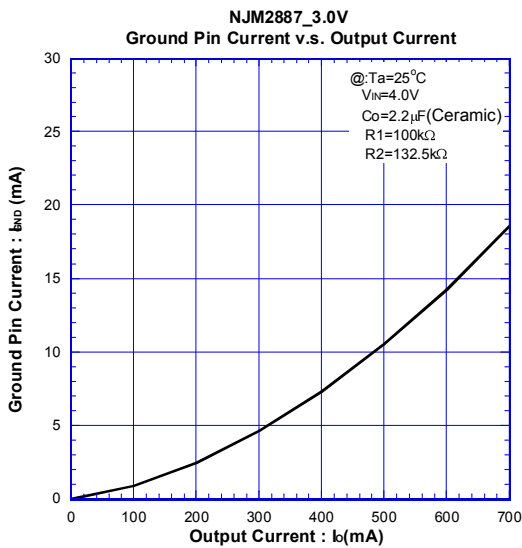
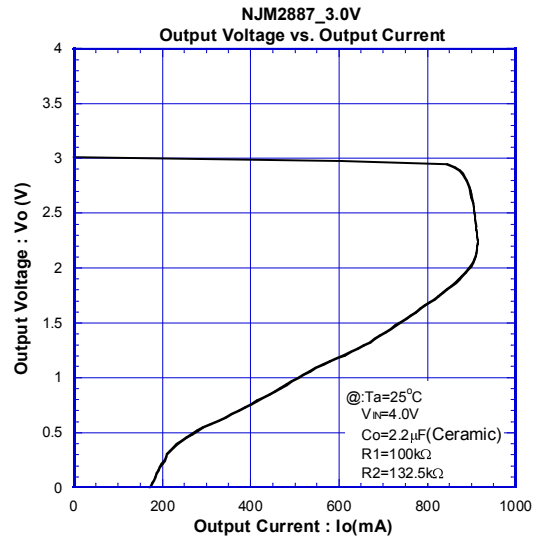
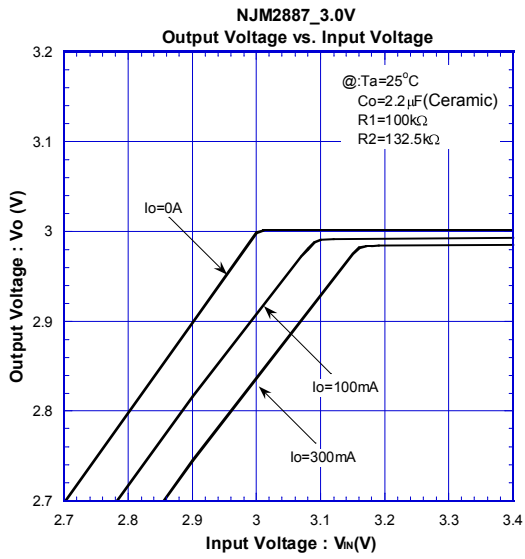

ELECTRICAL CHARACTERISTICS

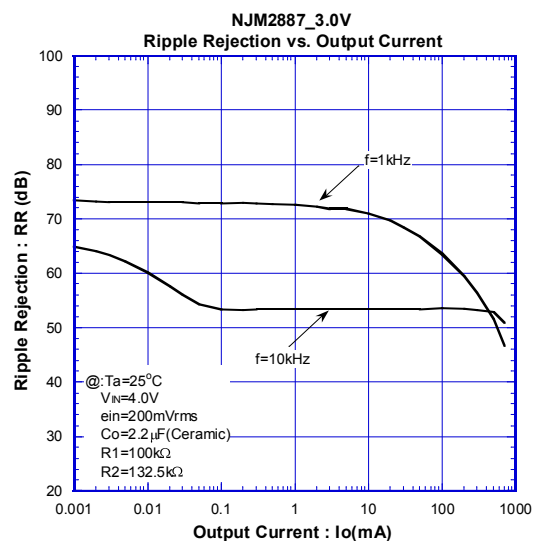
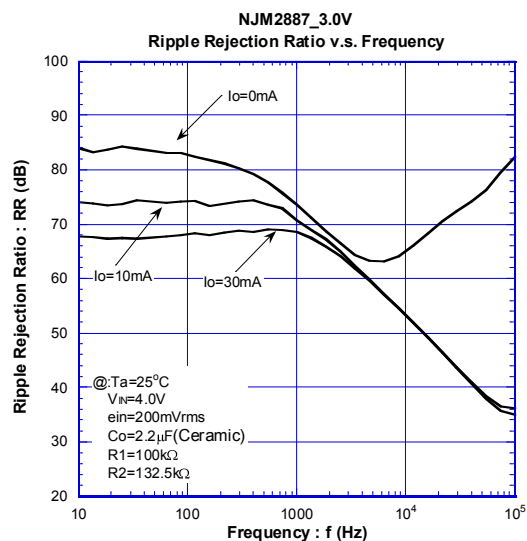
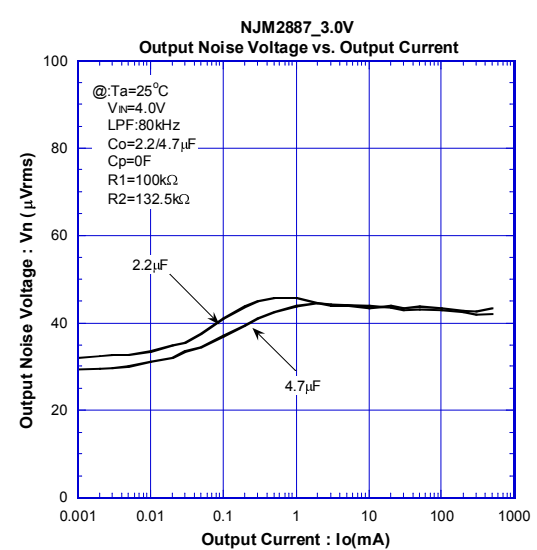
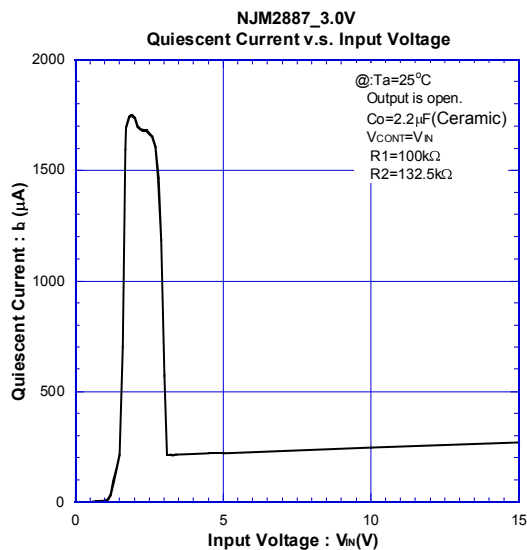
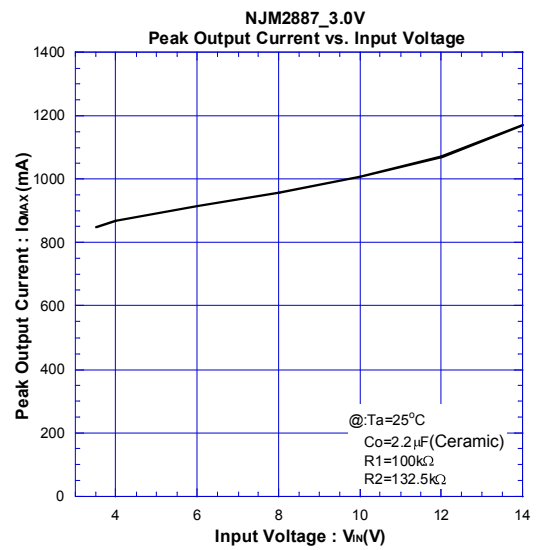
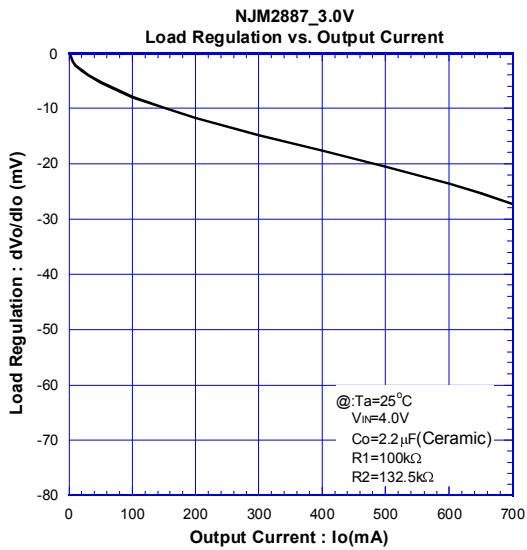

ELECTRICAL CHARACTERISTICS

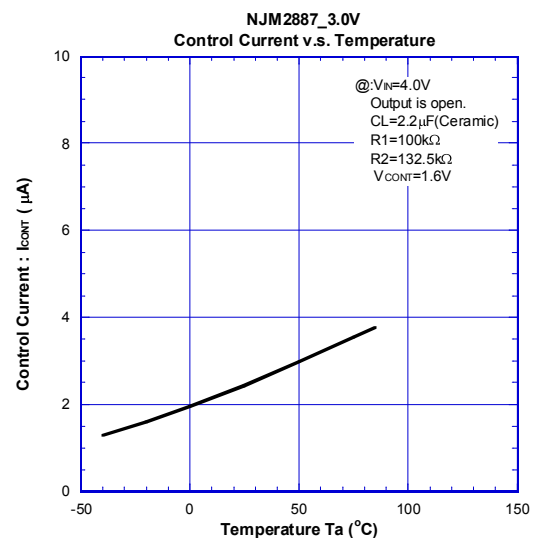
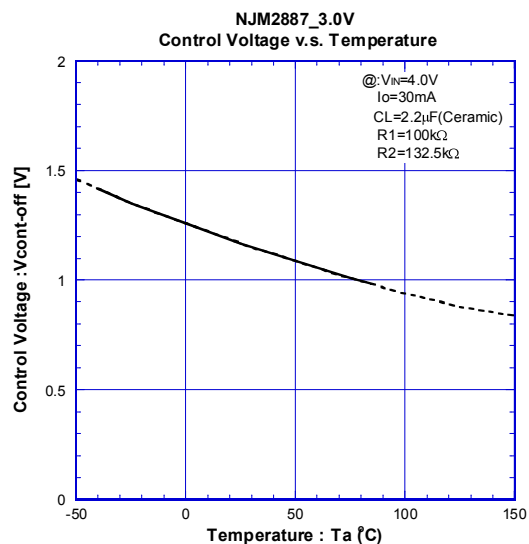
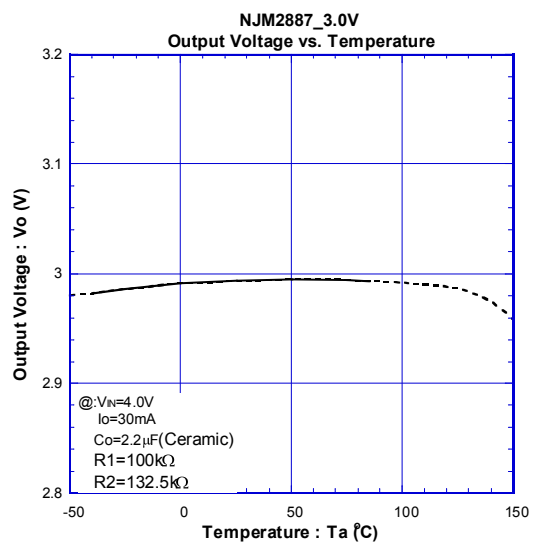
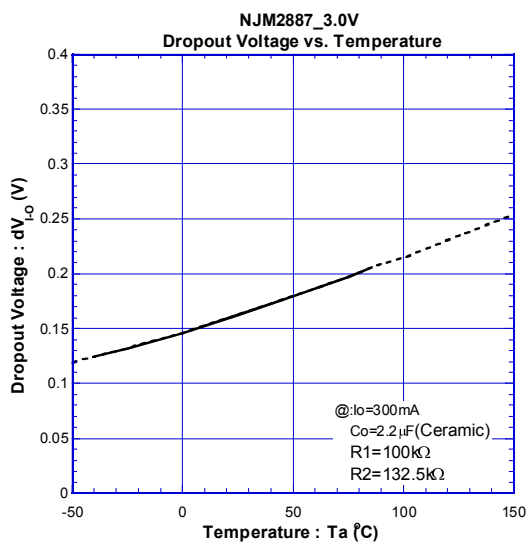
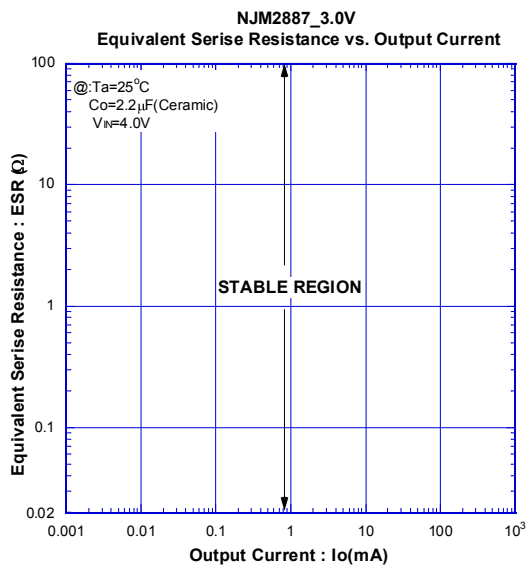

ELECTRICAL CHARACTERISTICS

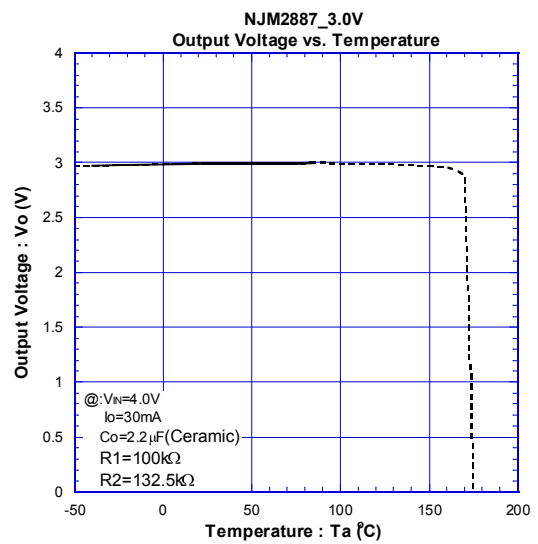
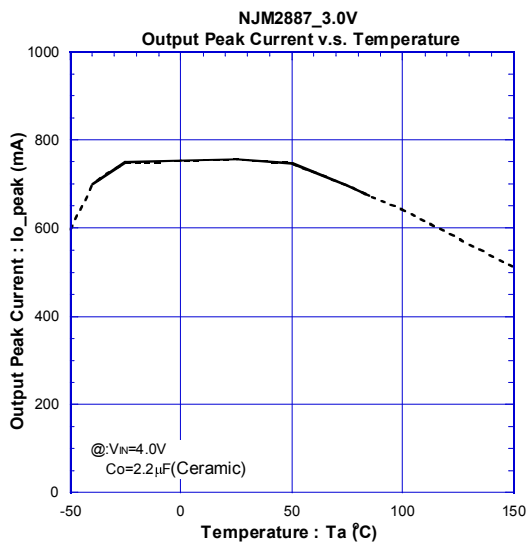
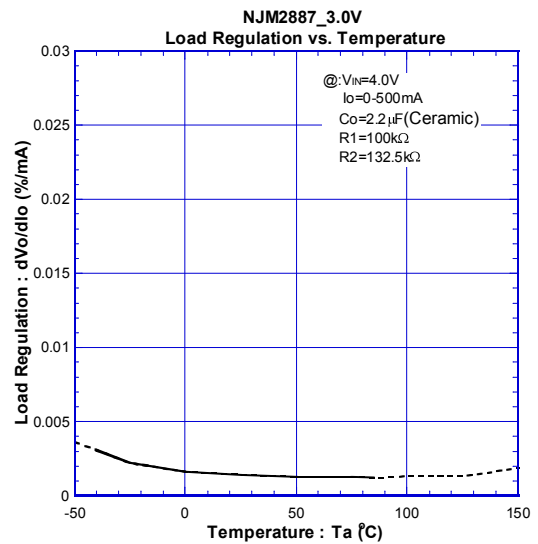
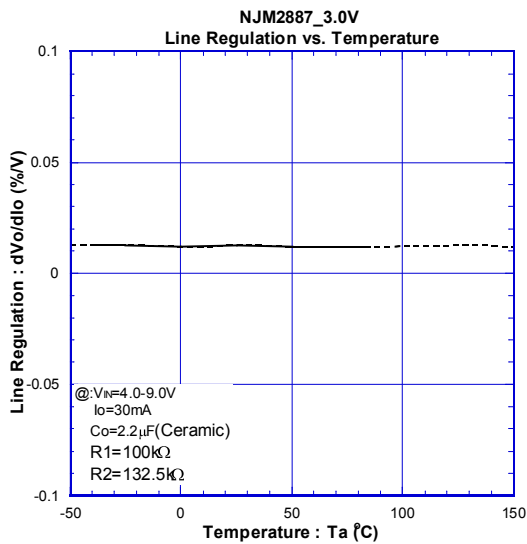
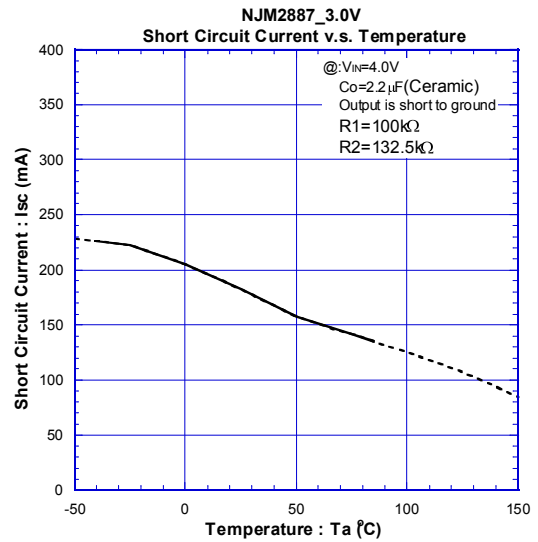
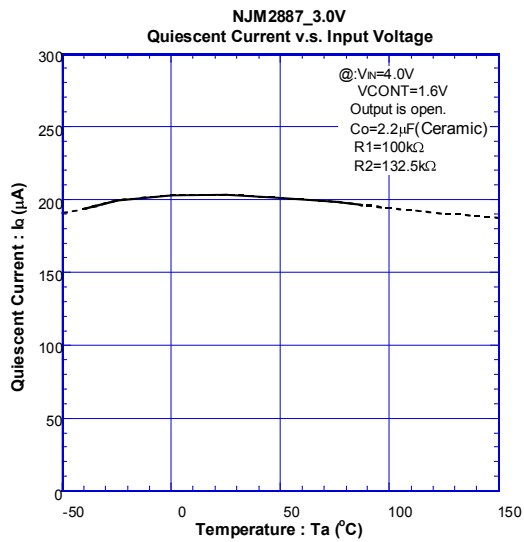

■ ELECTRICAL CHARACTERISTICS

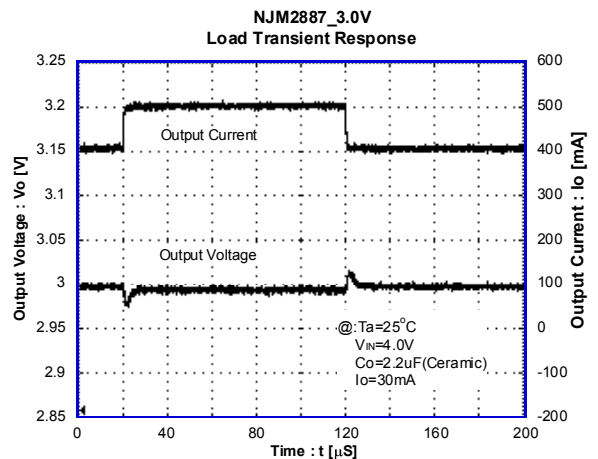
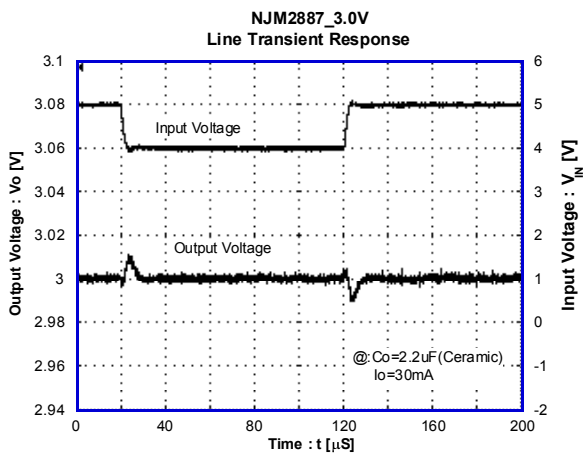
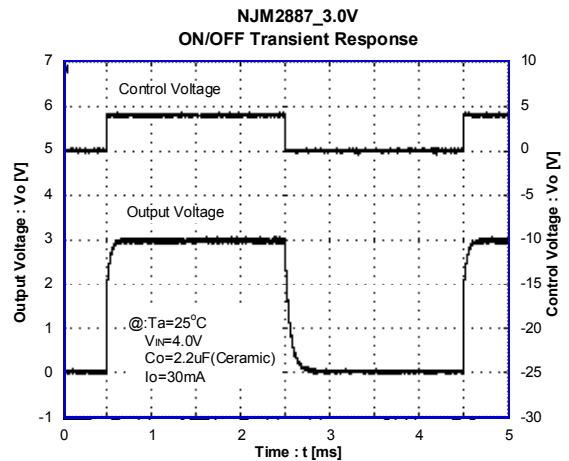
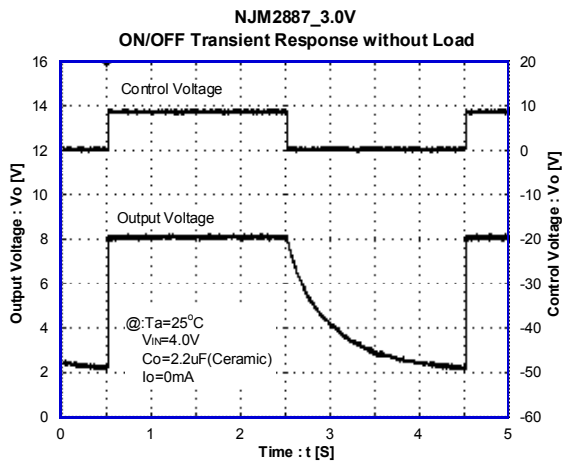

[CAUTION]
The specifications on this databook are only given for information, without any guarantee as regards either mistakes or omissions. The application circuits in this databook are described only to show representative usages of the product and not intended for the guarantee or permission of any right including the industrial rights.