

NCT7904D

H/W Monitor

Date: 2017/07/25 Revision: 1.45

Table of Content-

1.	GENERAL DESCRIPTION	7
2.	FEATURES	8
2.1	Equipped Specific Interfaces	8
2.2	Monitoring Items	8
2.3	PECI (Platform Environment Control Interface).....	8
2.4	SMART FAN™ PWM Output Control	9
2.5	Alarm Output.....	9
2.6	Self-initialization	9
2.7	SMBus Master	9
2.8	General	9
3.	KEY SPECIFICATIONS	10
4.	PIN CONFIGURATION	11
5.	PIN DESCRIPTION.....	12
5.1	Pin Type Description.....	12
5.2	Pin Description List	12
6.	FUNCTIONAL DESCRIPTION.....	17
6.1	Access Interface	17
6.1.1	Data write to the internal register.....	17
6.1.2	Data read from the internal register	17
6.2	Address Setting.....	18
6.3	Temperature Monitor Data Format	18
The temperature data with 11-bit 2's complement format.....	18	
6.4	Voltage Sense Data Format	18
6.5	FAN_IN Count Calculation.....	19
6.6	FAN_OUT Duty Cycle/DC output Calculation	19
6.7	Fan Speed Control.....	19
6.7.1	Step Up Time / Step Down Time	19
6.7.2	Fan Output Nonstop Value	19
6.7.3	Smart Fan Control Table	19
6.7.4	DTS (Sensor) Based Fan Control.....	21
6.8	PECI.....	22
6.8.1	Operation Mode	22
6.8.2	CPU Temperature and Power Reporting.....	22
6.8.3	DRAM Thermal Data Reporting.....	23
6.8.4	PECI Listening	24
6.9	SMI# Output.....	25
6.9.1	Temperature	25
6.9.2	Voltage	27
6.9.3	Fan	27
6.10	EEPROM Self-Initialization	28
6.10.1	EEPROM Format.....	28
6.10.2	Chip Initialization.....	28
6.11	PCH Thermal Data Report.....	29
6.11.1	PCH Thermal Read	29
6.11.2	PCH Thermal Data Format	29

6.12	SMBus Master Auto Read External Thermal Sensor	29
6.12.1	External Thermal Sensor Setting	29
6.12.2	Temperature Read Process	29
6.13	PROCHOT# Behavior	29
6.13.1	PROCHOT# Input	29
6.13.2	PROCHOT# Output	29
6.14	LED Behavior	30
6.14.1	Event Trigger LED	30
6.14.2	Programmable LED	30
6.15	BEEP Function	30
6.15.1	Output Signaling	30
6.15.2	BEEP Activation	30
6.16	THERMTRIP# Function	30
6.16.1	Power by VSB	30
6.16.2	Power Only by VBAT	30
7.	REGISTER DESCRIPTION	31
7.1	Bank 0 REGISTER DETAIL	31
7.1.1	Global Control Register	31
7.1.2	SMB Slave Address Register	31
7.1.3	Nuvoton Vendor ID Register	32
7.1.4	Nuvoton Chip ID Register	32
7.1.5	Nuvoton Device ID Register	32
7.1.6	Programmable LED Register	32
7.1.7	Event Control LED Register	33
7.1.8	Monitor Enable Control Register	33
7.1.9	Monitor Configuration Register	38
7.1.10	Voltage Channel and Temperature Monitored Value Register	41
7.1.11	PROCHOT Monitored Value Register	42
7.1.12	Nuvoton Vendor ID Register	43
7.1.13	Nuvoton Chip ID Register	43
7.1.14	Nuvoton Device ID Register	43
7.1.15	FAN Tachometer Monitored Value Register	43
7.1.16	DTS Temperature Monitored Value Register	44
7.1.17	Virtual Temperature Value Register	46
7.1.18	External and Virtual Temperature Value Register	47
7.1.19	SMI Control Register	48
7.1.20	SMI Status Register	48
7.1.21	SMI Mask Register	50
7.1.22	Beep Control Register	52
7.1.23	Beep Source Selection Register	52
7.1.24	Lock Watch Dog Register	54
7.1.25	Watch Dog Enable Register	54
7.1.26	Watch Dog Status Register	54
7.1.27	Watch Dog Timer Register	55
7.1.28	GPIO Control Register	55
7.1.29	PCH DTS Monitored Value Register	57
7.1.30	Bank Select Register	60

7.2	Bank 1 REGISTER DETAIL.....	61
7.2.1	Voltage and Temperature Channel Limitation Register	61
7.2.2	PROCHOT Limitation Register	64
7.2.3	FAN Input Channel Limitation Register.....	64
7.2.4	DTS Temperature Power Limitation Registers.....	65
7.2.5	PROCHOT Control Registers	67
7.2.6	PROCHOT Source Selection Registers.....	68
7.2.7	Voltage Fault Control Registers.....	70
7.2.8	Voltage Fault Source Selection Registers	70
7.2.9	Fan Fault Control Registers	72
7.2.10	Fan Fault Source Selection Registers	72
7.2.11	Temperature Fault Control Registers.....	74
7.2.12	Temperature Fault Source Selection Registers	74
7.2.13	THERMTRIP Control and Status Register.....	75
7.3	Bank 2 REGISTER DETAIL.....	77
7.3.1	PECI Function Enable Register (PFE).....	77
7.3.2	PECI Timing Configure Register (PTC)	77
7.3.3	PECI Agent and Domain Configure Register (PADC).....	78
7.3.4	PECI Relative Temperature Scale Register (PRTS).....	79
7.3.5	DTS Power Source Control Register	80
7.3.6	TBit Width Register (TBW).....	80
7.3.7	PECI Listening Mode Configuration Register (PLMC)	81
7.3.8	PECI VTT Power Detect Configuration Register (PVCR)	81
7.3.9	PECI Agent Tbase Temperature Register (PATB).....	82
7.3.10	PECI Power Averaging Configure Register (PPAC)	83
7.3.11	Averaging DTS Based Thermal Spec Configure Register (ADBTSC)	84
7.3.12	PECI Manual Mode Configure Register (PMMC).....	85
7.3.13	PECI Manual Mode Write Data Register (PMMWD).....	86
7.3.14	PECI Manual Mode Read Data Register (PMMRD)	86
7.3.15	Agent Relative Temperature Registers (ARTR).....	89
7.3.16	TSI Control Registers	91
7.3.17	TSI Client Enable Registers.....	91
7.3.18	TSI Manual Configuration Registers	91
7.3.19	TSI Test Mode Registers	92
7.3.20	TSI Manual Address Registers	92
7.3.21	TSI Manual Command Registers.....	92
7.3.22	TSI Manual Write Data Registers	93
7.3.23	TSI Manual Read Data Registers	93
7.3.24	PCH Read Control Registers.....	93
7.3.25	PCH Client Address Registers.....	93
7.3.26	PCH Command Registers	94
7.3.27	PCH Read Byte Count Registers.....	94
7.3.28	SMBUS Master Manual Configuration Registers.....	94
7.3.29	SMBUS Master Manual Address Registers	95
7.3.30	SMBUS Master Manual Command Registers.....	95
7.3.31	SMBUS Master Manual Write Data Registers	95
7.3.32	SMBUS Master Manual Read Data Registers	95
7.3.33	External Read Control Registers	95

7.3.34	External Read Address and Command Register	96
7.3.35	Power Unit Status	97
7.3.36	Energy Unit Status	98
7.3.37	Retrieving Margin Status Control Registers	98
7.3.38	Tjmax Temperature Target Read/Write for CPU Agent (Address : 30h ~ 33h).....	99
7.3.39	Tcontrol Temperature Target Read/Write for CPU Agent (Address : 30h ~ 33h)...	100
7.3.40	Thermal Design Power (TDP) Status for CPU Agent (Address : 30h ~ 33h)	100
7.3.41	Margin Status for CPU Agent (Address : 30h ~ 33h)	101
7.3.42	Power Reporting Factor for CPU Agent (Address : 30h ~ 33h)	101
7.3.43	DTS DRAM Temperature Monitor Enable Control Register.....	102
7.3.44	DRAM Temperature Value Register (Reterived by PECl RdPkgConfig command)	104
7.4	Bank 3 REGISTER DETAIL.....	112
7.4.1	Temperature to Fan Mapping Relationships (TFMR).....	112
7.4.2	Default Fan Speed at Power-on (DFSP).....	112
7.4.3	SmartFan Output Step Up Time (SFOSUT)	113
7.4.4	SmartFan Output Step Down Time (SFOSDT)	113
7.4.5	3-Wire Fan Enable and Fan Output Mode Control (FOMC).....	113
7.4.6	Close-Loop Fan control RPM mode and Tolerance (CLFR)	114
7.4.7	Temperature Source Selection (TSS).....	114
7.4.8	Power Accumulate Enable (PAE)	116
7.4.9	Close-Loop Fan Control RPM mode for High Speed Fan Register (RHSF)	117
7.4.10	PROCHOT Fan Select (PFS)	117
7.4.11	Fan Output Value (FOV).....	118
7.4.12	Fan Output PWM Frequency Prescalar (FOPFP).....	118
7.4.13	Fan Output Nonstop Enable (FONE)	119
7.4.14	Fan Tachometer Source Selection (FTSS).....	119
7.4.15	Fan Tachometer Source Selection (FTSS).....	120
7.4.16	Critical Temperature to Full Speed all fan (CTFS).....	121
7.4.17	Hysteresis of Temperature (HT)	121
7.4.18	Fan Output Nonstop Value(FONV)	122
7.4.19	SMART FAN™ IV Temperature and DC/PWM Table (SFIV).....	122
7.4.20	Configure Register of PECl Error (CRPE)	123
7.4.21	Fan Output Min Value when PECl Error (FOMV)	124
7.4.22	Mask Register of PECl Error (MRPE).....	124
7.4.23	PECl T_DTS Slope Value (PTSV)	124
7.4.24	PECl T_DTS Offset Value (PTOV)	125
7.4.25	Tcontrol_Offset Value for CPU Agent (Address : 30h ~ 33h) (TOV).....	125
7.4.26	DTS Delta Tolerance Value (DDTV)	126
7.4.27	DTS Margin Divisor (DMD)	127
7.5	Bank 4 REGISTER DETAIL.....	128
7.5.1	Temperature to Fan Mapping Relationships (TFMR).....	128
7.5.2	Temperature Source Selection (TSS).....	128
7.5.3	Critical Temperature to Full Speed all fan (CTFS).....	130
7.5.4	Hysteresis of Temperature (HT)	131
7.5.5	SMART FAN™ IV Temperature and DC/PWM Table (SFIV).....	131
8.	ELECTRICAL CHARACTERISTICS	133
8.1	Absolute Maximum Ratings	133

8.2 DC Specification 133

8.3 AC Specification..... 134

9. ORDER INFORMATION 136

10. TOP MARKING SPECIFICATIONS..... 137

11. PACKAGE DRAWING AND DIMENSIONS..... 138

12. REVISION HISTORY 139

1. GENERAL DESCRIPTION

NCT7904D is an evolving version of the Nuvoton popular Hardware Monitor IC family. NCT7904D provides several innovative features, Intel PECI1.1/2.0/3.0 interface, and PROCESSOR HOT feature. Conventionally, NCT7904D can be used to monitor several critical hardware parameters of the system, including power supply voltages, fan speeds, and temperatures, which are very important for a high-end computer system, such as server, workstation...etc, to work stably and efficiently.

A 10-bit analog-to-digital converter (ADC) is built inside NCT7904D. NCT7904D can simultaneously monitor 20 analog voltage inputs (including power 3VDD / 3VSB / VBAT / VTT monitoring), 12 fan tachometer inputs, 4 fan output control, and 4 remote temperature sensor inputs, 2 of which support current mode (dual current source) temperature measurement method, it also supports caseopen detection, Watch Dog Timer function, and GPIO pins. The sense of remote temperature can be performed by thermistors, or directly from thermal diode. NCT7904D provides PWM (pulse width modulation) for each fan control output pin, and DC fan output mode is supported on PWM4 pin. Meanwhile, the NCT7904D provides SMART FAN™ control, the “SMART FAN™ IV” mode equips with 4 sets of temperatures setting point each could control fan's duty cycle, to make the fans could be operated at the lowest possible speed and the acoustic could be balanced. As for warning mechanism, NCT7904D provides SMI#, TEMP_ALM#, VOLT_ALM#, and FAN_ALM# to protect the system. NCT7904D has 1 specific pin to provide address selection so that 2 NCT7904D could be wired through SMBus interface at the same time.

All of the monitored parameters of the system could be read from time to time through the BIOS or any management application software. Nuvoton supports the software – “Health Manager” to provide an easy way to monitor and show the hardware parameters, such as temperature, voltage and fan speed inputs, furthermore, it provides a convenient method to do the fan control. It can also show the alarm message when the monitored hardware parameter exceeds the limit, and recodes the history events.

2. FEATURES

2.1 Equipped Specific Interfaces

- I²C / SMBus2.0 Serial Bus Master (max. 400KHz Clock)
- I²C / SMBus2.0 Serial Bus Slave (max. 400KHz Clock)
- Intel® PECCI (PLATFORM ENVIRONMENT CONTROL INTERFACE) 1.0 / 2.0 / 3.0
- AMD SB-TSI

2.2 Monitoring Items

VOLTAGE

Up to 20 voltage sensing inputs

- 16 general voltage inputs
- 4 power pins. (3VDD, 3VSB, VBAT and VTT)
- 4 multi-functions with thermistor temperature inputs (on VSEN2, VSEN4, VSEN6, VSEN8)
- 2 multi-functions with thermal diode pair (on VSEN2, VSEN3, VSEN4 and VSEN5)

TEMPERATURE

Up to 4 methodologies for capturing temperature information

- ADC
 - => 2-pair thermal diode channel (current mode) / 4-channel thermistor mode temperature
 - => 1 channel on-chip temperature sensor
- Intel® PECCI interface
 - => Automatically retrieving CPU temperature
- AMD SB-TSI interface
 - => Automatically retrieving CPU temperature
- SMBus Master
 - => Reading MCH, PCH, CPU and DIMMs temperature through PCH
 - => Reading specific external at most 4 thermal sensors.

FAN SPEED

Up to 12 fan tachometer inputs

2.3 PECCI (Platform Environment Control Interface)

- Support PECCI 1.0 / 2.0 / 3.0 full commands
- Automatically retrieve CPU temperature and power status
- Automatically retrieve DRAM thermal data which is provided by CPU0 and CPU1 only (Address: 30h and 31h)
- Support 4 CPU sockets (eq. 4 PECCI address) and 2 domains per CPU address

2.4 SMART FAN™ PWM Output Control

- Up to 4 PWM Outputs
- Support 2 modes of fan speed control: SMART FAN™ IV mode and Closed Loop Fan Control Mode (RPM mode)
- Provide up to 10 SMART FAN™ tables to characterize 10 relationships between temperature and output fan speed
- The temperature source of table could come from any of temperature information captured from ADC, PECL, TSI and SMBus Master
- Multiple temperature sources could affect multiple fan control outputs
- Up to 4 virtual temperature sources feed by host as the parts of fan temperature sources
- Up to 4 external temperature sources read from SMBus master I/F which can be the part of fan temperature sources
- Support Fan Control for Intel Sandy Bridge-EP/EX DTS specification
- Support DTS (Sensor) Based Thermal Ver. 1.0/2.0 Spec to optimize fan speed control and acoustics at processor run time

2.5 Alarm Output

- Issue SMI# signal to activate system protection
- Issue voltage, temperature and fan alarm signals to activate system protection

2.6 Self-initialization

- Self-configuration by reading external EEPROM with SMBus interface

2.7 SMBus Master

- Support SMBus master function to read EEPROM configuration data and other SMBus devices
- Support SMBus master manual byte read and byte write
- Support accessing PCH Thermal Reporting
- Support accessing external thermal sensors

2.8 General

- Provide up to 11 GPIO pins (GPIO13~16, GPIOA~G, multi-function with other function pins)
- LED indication with programmable blinking frequency
- Event trigger LED by the external signal with programmable blinking frequency
- I²C / SMBus2.0 serial bus interface (max. 400KHz Clock)
- Watch Dog Timer function with an output signal(WDT_RSTOUT#)
- 1 address selection pins provide 2 selectable SMBus addresses
- 3.3V operationPackage
- Packaged in 48-LQFP(7mm x 7mm) type, RoHS-Compliant and Halogen free

3. KEY SPECIFICATIONS

- Voltage monitoring accuracy
 - VSEN inputs ±10mV
 - Power inputs and VSEN17,18,19 inputs ±60mV
- Temperature Sensor Accuracy
 - Remote Diode Sensor Accuracy (25~85°C) ± 1°C typ.
 - On-chip Temperature Sensor Accuracy (25~70°C) ± 1°C typ.
 - Remote Diode Sensor Resolution 0.125 °C
 - On-chip Temperature Sensor Resolution 0.125 °C
- Supply Voltage 3.3V ± 5%
- Operating Supply Current 15 mA typ.
- Operating Temperature Range -40°C ~ 120°C ^{*1}

^{*1} Guaranteed by design from -40~120 °C, 100% tested at 85°C.

4. PIN CONFIGURATION

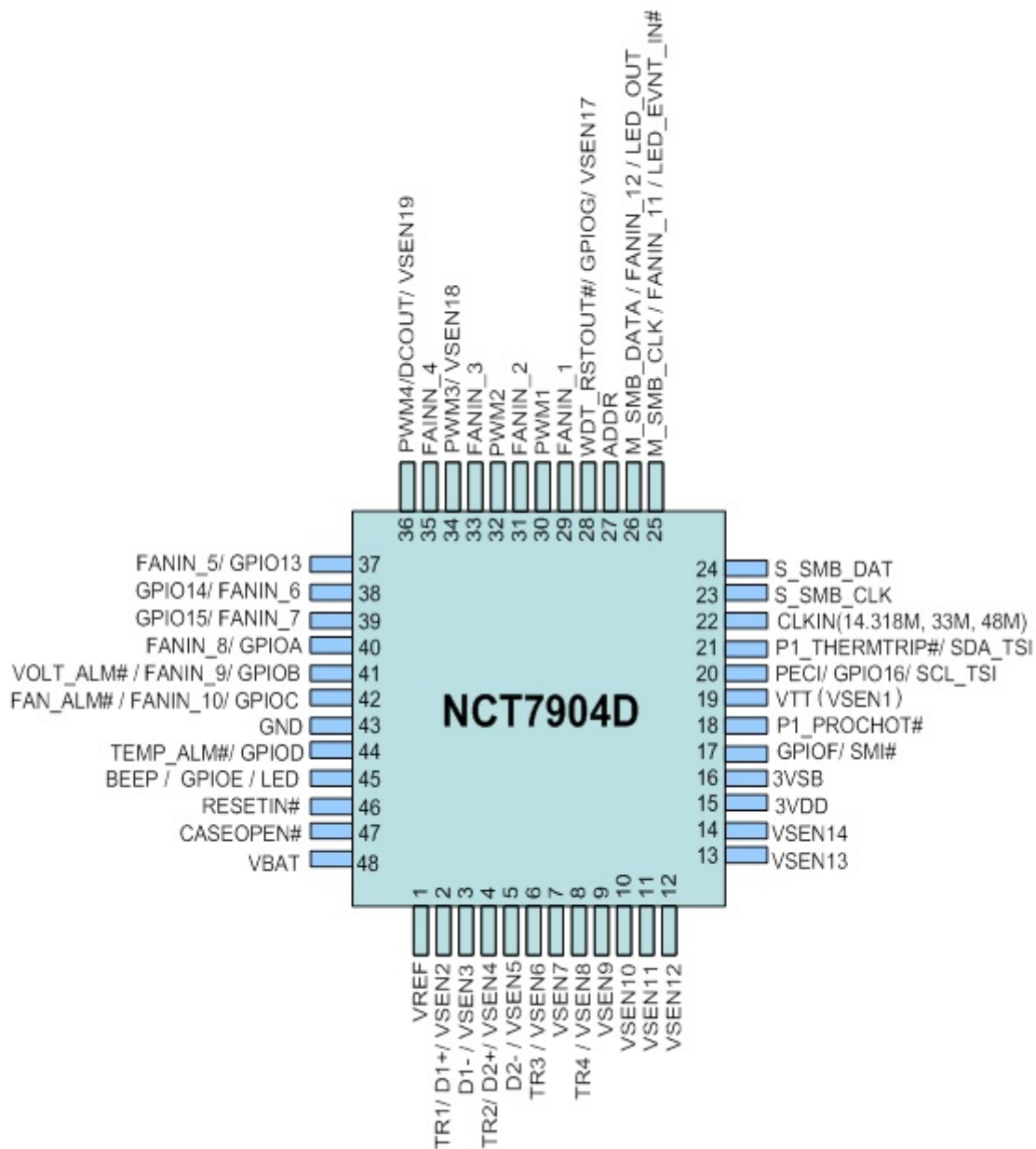

5. PIN DESCRIPTION

5.1 Pin Type Description

SYMBOL	DESCRIPTION
TTL	TTL level
GTL	VTT level
TSI	TSI level
I	Input
O	Output (Push-pull)
OD	Open-drain output
AIN	Input pin(Analog)

5.2 Pin Description List

PIN NAME	PIN NO.	POWER PLANE	TYPE	DESCRIPTION
VREF	1	3VSB	AOUT	Reference voltage output. This pin is for thermistor application
TR1	2	3VSB	AIN	Thermistor 1 sensing input
D1+				Thermal diode 1 D+
VSEN2				Voltage sensing input. Detection range is 0~2.048V. (default)
D1-	3	3VSB	AIN	Thermal diode 1 D-
VSEN3				Voltage sensing input. Detection range is 0~2.048V
TR2	4	3VSB	AIN	Thermistor 2 sensing input
D2+	5	3VSB	AIN	Thermal diode 2 D+
VSEN4				Voltage sensing input. Detection range is 0~2.048V.(default)
D2-				Thermal diode 2 D-
VSEN5	5	3VSB	AIN	Voltage sensing input. Detection range is 0~2.048V
TR3				6

PIN NAME	PIN NO.	POWER PLANE	TYPE	DESCRIPTION
VSEN6				Voltage sensing input. Detection range is 0~2.048V
VSEN7	7	3VSB	AIN	Voltage sensing input. Detection range is 0~2.048V
TR4	8	3VSB	AIN	Thermistor 4 sensing input
VSEN8				Voltage sensing input. Detection range is 0~2.048V
VSEN9	9	3VSB	AIN	Voltage sensing input. Detection range is 0~2.048V
VSEN10	10	3VSB	AIN	Voltage sensing input. Detection range is 0~2.048V
VSEN11	11	3VSB	AIN	Voltage sensing input. Detection range is 0~2.048V
VSEN12	12	3VSB	AIN	Voltage sensing input. Detection range is 0~2.048V
VSEN13	13	3VSB	AIN	Voltage sensing input. Detection range is 0~2.048V
VSEN14	14	3VSB	AIN	Voltage sensing input. Detection range is 0~2.048V
3VDD	15		POWER	+3V VDD power. It is also a voltage monitor channel Bypass with the parallel combination of 10 μ F (electrolytic or tantalum) and 0.1 μ F (ceramic) bypass capacitors
3VSB	16	-	POWER	+3V VSB power. It is also a voltage monitor channel Bypass with the parallel combination of 10 μ F (electrolytic or tantalum) and 0.1 μ F (ceramic) bypass capacitors
GPIOF	17	3VSB	TTL I/OD	General Purpose I/O F (default)
SMI#		3VSB	TTL OD	System Management Interrupt.
P1_PROCHOT#	18	3VSB	GTL I/O	CPU1 PROCHOT# signal
VTT (VSEN1)	19	--	POWER	VTT power pin. This power will be also monitored as VSEN1
PECI	20	VTT	GTL I/O	Intel [®] PECI interface signal. The power source is pin 19 (VTT)
GPIO16		3VSB	TTL I/OD	General Purpose I/O 16

PIN NAME	PIN NO.	POWER PLANE	TYPE	DESCRIPTION
SCL_TSI		3VSB	TSI OD	Clock line of AMD® SB_TSI interface
P1_THERMTRIP#	21	3VSB	GTL I	CPU1 THERMTRIP# signal. Pull-down it when unused.
SDA_TSI		3VSB	TSI I/OD	Data line of AMD® SB_TSI interface
CLKIN(33M, 14.318M, 48M)	22	3VSB	TTL I	Clock input. 14.318MHz or 33MHz or 48MHz could be applied to this pin with corresponding register configuration. Default setting is for 33MHz This clock is for PECl and fan speed monitor
S_SMB_CLK	23	3VSB	TTL I	SMBus clock line for this device being slave device
S_SMB_DATA	24	3VSB	TTL I/OD	SMBus data line for this device being slave device
M_SMB_CLK	25	3VSB	TTL OD	SMBus clock line for this device being master device
FANIN_11			TTL I	Fan tachometer input
LED_EVNT_IN#			TTL I	An input event to trigger LED_OUT
M_SMB_DATA	26	3VSB	TTL I/OD	SMBus data line for this device being master device
FANIN_12			TTL I	Fan tachometer input
LED_OUT			TTL OD	When pin LED_EVNT_IN is asserted a low pulse, this pin will output a pulse to drive LED on or blinking
ADDR	27	3VSB	TTL I	SMBus slave address strap selection pin Strapped to low, the 7-bit address is 0101101 Strapped to high, the 7-bit address is 0101110
WDT_RSTOUT#	28	3VSB	TTL OD	Watch dog timer reset output
GPIOG			TTL I/OD	General Purpose I/O G (default)
VSEN17			AIN	Voltage sensing input. Detection range is 0~3.3V
FANIN_1	29	3VSB	TTL I	Fan tachometer input
PWM1	30	3VSB	TTL OD	Fan speed control PWM output. This is 5V tolerant
FANIN_2	31	3VSB	TTL I	Fan tachometer input

PIN NAME	PIN NO.	POWER PLANE	TYPE	DESCRIPTION
PWM2	32	3VSB	TTL OD	Fan speed control PWM output. This is 5V tolerant
FANIN_3	33	3VSB	TTL I	Fan tachometer input
PWM3	34	3VSB	TTL OD	Fan speed control PWM output. This is 5V tolerant
VSEN18			AIN	Voltage sensing input. Detection range is 0~3.3V
FANIN_4	35	3VSB	TTL I	Fan tachometer input
PWM4/DCOUT	36	3VSB	TTL OD AOUT	Fan speed control PWM or DC output. A register bit could be programmed to select PWM or DC mode. DC output is default mode. This is without 5V tolerant
VSEN19			AIN	Voltage sensing input. Detection range is 0~3.3V
FANIN_5	37	3VSB	TTL I	Fan tachometer input.(default)
GPIO13		3VSB	TTL I/OD	General Purpose I/O 13
FANIN_6	38	3VSB	TTL I	Fan tachometer input (default)
GPIO14		3VSB	TTL I/OD	General Purpose I/O 14
FANIN_7	39	3VSB	TTL I	Fan tachometer input (default)
GPIO15		3VSB	TTL I/OD	General Purpose I/O 15
FANIN_8	40	3VSB	TTL I	Fan tachometer input (default)
GPIOA		3VSB	TTL I/OD	General Purpose I/O A
VOLT_ALM#	41	3VSB	TTL OD	Voltage abnormal alert output signal (active low)
FANIN_9		3VSB	TTL I	Fan tachometer input (default)
GPIOB		3VSB	TTL I/OD	General Purpose I/O B
FAN_ALM#	42	3VSB	TTL OD	Fan speed abnormal alert output signal (active low)
FANIN_10		3VSB	TTL I	Fan tachometer input (default)

PIN NAME	PIN NO.	POWER PLANE	TYPE	DESCRIPTION
GPIOC		3VSB	TTL I/OD	General Purpose I/O C
GND	43		POWER	GROUND
TEMP_ALM#	44	3VSB	TTL OD	Temperature abnormal alert output signal (active low)
GPIOD			TTL I/OD	General Purpose I/O D (default)
LED	45	3VSB	TTL OD	Programmable frequency LED output signal
GPIOE			TTL I/OD	General Purpose I/O E (default)
BEEP			TTL OD	Beeper signal output when over heat event happens
RESETIN#	46	3VSB	TTL I	System reset input
CASEOPEN#	47	VBAT	TTL I	Case Open detection input signal. An active low input from an external device when case is opened. This event will be latched even when the case is closed. Pull-down it when unused.
VBAT	48		POWER	VBAT power for Case Open detection and status log

*** The recommended connection for Unused Pin**

- (1) For digital input pin, pull down to GND.
- (2) For digital output pin, keep floating.
- (3) For analog input pin, keep floating.
- (4) For analog output pin, keep floating.
- (5) For VTT pin, keep floating.
- (6) For VBAT pin, connect to 3VSB.

6. FUNCTIONAL DESCRIPTION

6.1 Access Interface

NCT7904D provides SMBus interface, which is compliant with SMBus 2.0 specification. The 7-bit serial address is selected to be 0101101 or 0101110 by pin ADDR. When pin ADDR is strapped to low, the SMBus address is 0x5A(write)/0x5B(read) ; when pin ADDR is strapped to high, the SMBus address is 0x5C(write)/0x5D(read).

NCT7904D supports the bus speed with 0~400KHz.

6.1.1 Data write to the internal register

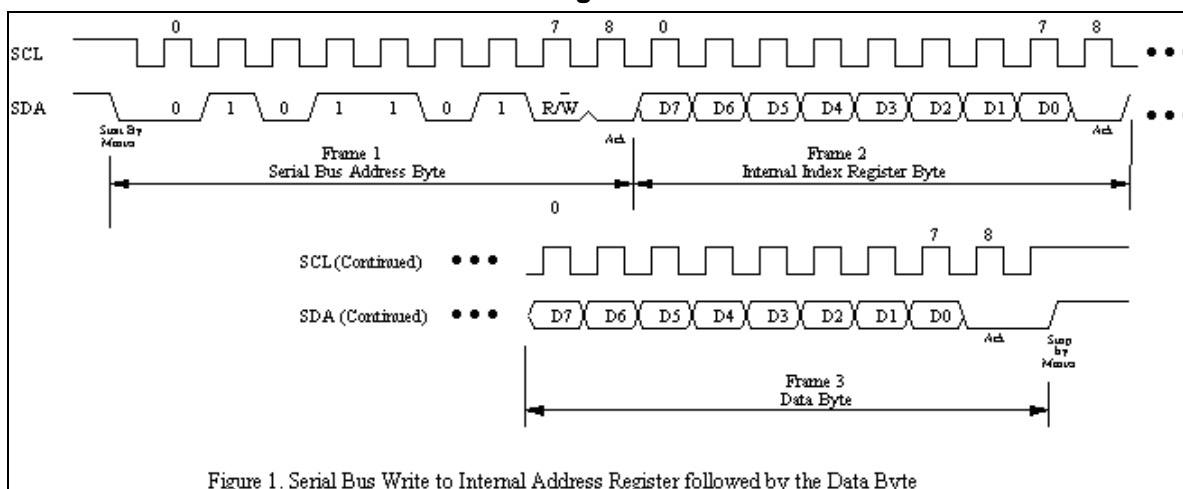

Figure 1. Serial Bus Write to Internal Address Register followed by the Data Byte

6.1.2 Data read from the internal register

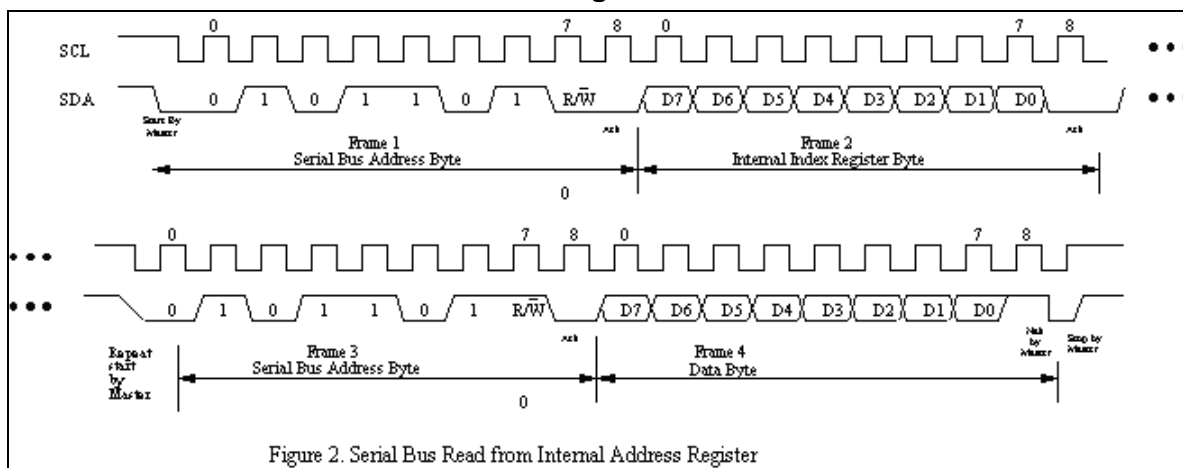

Figure 2. Serial Bus Read from Internal Address Register

6.2 Address Setting

NCT7904D has one address selection pin, the SMBus address will be strapped when 3VSB ready. The address will be retained as long as the 3VSB of NCT7904D is maintained. The pull-up power plane must be the same as the 3VSB power of NCT7904D.

ADDR	ADDRESS
0	0101 101X
1	0101 110X

X=Read/Write Bit

6.3 Temperature Monitor Data Format

The temperature data with 11-bit 2`s complement format

TEMPERATURE	8-BIT DIGITAL OUTPUT HIGH BYTE	3-BIT DIGITAL OUTPUT LOW BYTE
+127.875°C	0111,1111	XXXX,X111
+25.750°C	0001,1001	XXXX,X110
+2.250°C	0000,0010	XXXX,X010
+1.125°C	0000,0001	XXXX,X001
+0.000°C	0000,0000	XXXX,X000
- 1.125°C	1111,1110	XXXX,X111
- 2.250°C	1111,1101	XXXX,X110
- 25.750°C	1110,0110	XXXX,X010
- 127.875°C	1000,0000	XXXX,X001

6.4 Voltage Sense Data Format

VSEN Low Byte together with VSEN High Byte forms the 11-bit count value. If VSEN High Byte readout is read successively, the NCT7904D will latch the VSEN Low Byte for next read. Then voltage readout high byte and low byte are combined to *11-bitVoltageValue*.

For voltage monitoring, real voltage calculations should follow the formula:

$$VSEN1\sim14 : Voltage(V) = 11bitCountValue \times 0.002$$

$$3VSB,3VDD,VBAT,VSEN17,18,19 : Voltage(V) = 11bitCountValue \times 0.006$$

* VSEN17,18,19 are embedded internal voltage divider resistors.

6.5 FAN_IN Count Calculation

The FAN_IN tachometer high byte and low byte are combined to 13-bitCountValue. Real RPM (Rotate per Minute) calculation should follow the formula:

$$FanSpeed(RPM) = \frac{1.35 \times 10^6}{(13 - bitCountValue) \times (FanPoles/4)}$$

In this formula, FanPole stands for the number of NS pole pairs inside the fan. Normally an N-S-N-S Fan (FanPole=4) generates 2 pulses after completing one rotation.

6.6 FAN_OUT Duty Cycle/DC output Calculation

The NCT7904D provides 4 set of PWM and 1 set of DC output for fan speed control. The duty cycle of PWM can be programmed by an 8-bit register. The expression of duty cycle can be represented as follow formula:

$$Duty - cycle(\%) = \frac{Programmed\ 8 - bit\ Register\ Value}{255} \times 100\%$$

The DC output can be programmed by an 8-bit register. The expression of DC level can be represented as follow formula:

$$DC\ output\ (V) = 3VDD \times \frac{Programmed\ 8 - bit\ Register\ Value}{255}$$

6.7 Fan Speed Control

Except for traditional Fan Duty control, the latest closed loop fan control (RPM Mode) has been provided by the NCT7904D. Due to PECL negative temperature format, the fan control also supports negative temperature representation. It would be much easy to implement fan control by PECL reading. In addition to PECL CPU temperature, the NCT7904D also supports fan control, which is responded to CPU power.

In Smart Fan Mode, there are some Fan control parameters as below descriptions:

6.7.1 Step Up Time / Step Down Time

Smart Fan is designed for the smooth operation of the fan. The Up Time / Down Time register defines the time interval between successive duty increases or decreases. If this value is set too small, the fan will not have enough time to speed up after tuning the duty and sometimes may result in unstable fan speed. On the other hand, if Up Time / Down Time is set too large, the fan may not work fast enough to dissipate the heat. This register should never be set to 0, otherwise, the fan duty will be abnormal.

6.7.2 Fan Output Nonstop Value

It takes some time to bring a fan from still to working state. Therefore, Nonstop value are designed with a minimum fan output to keep the fan working when the system does not require the fan to help reduce heat but still want to keep the fast response time to speed up the fan.

6.7.3 Smart Fan Control Table

SMART FAN™ IV and Close Loop Fan Control Mode offer 4 slopes to control the fan speed. The 3 slopes can be obtained by setting FanDuty/RPM1~FanDuty/RPM4 and T1~T4 through the registers. When the temperature rises, FAN Output will calculate the target Fan Duty/RPM based on the current slope. For example, assuming Tx is the current temperature and Fan Duty/RPMy is the target, then the slope:

$$X2 = \frac{(FanDuty3 / RPM3) - (FanDuty2 / RPM2)}{(T3 - T2)}$$

Fan Output:

$$Target\ FanDuty\ or\ RPM = (FanDuty2\ or\ RPM2) + (Tx - T2) \cdot X2$$

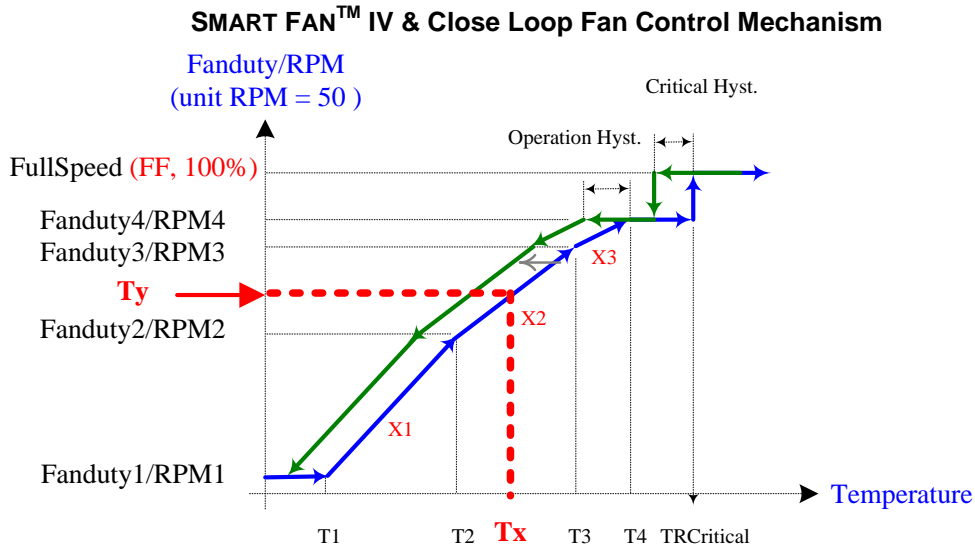

In addition, SMART FAN™ IV & Close Loop Fan Control can also set up Critical Temperature and Hysteresis. If the current temperature exceeds Critical Temperature, external fan will be forced by maximum Fan Duty to meet the largest target Fan Duty or RPM, Which is 0xFF. The target Fan Duty & RPM value will be determined in accordance to the slope only when the temperature falls below (TCritical – Critical Hyst.)

NCT7904D provides several temperature sources selects to map the fan, the algorithm will make a decision to control the fan as below figure:

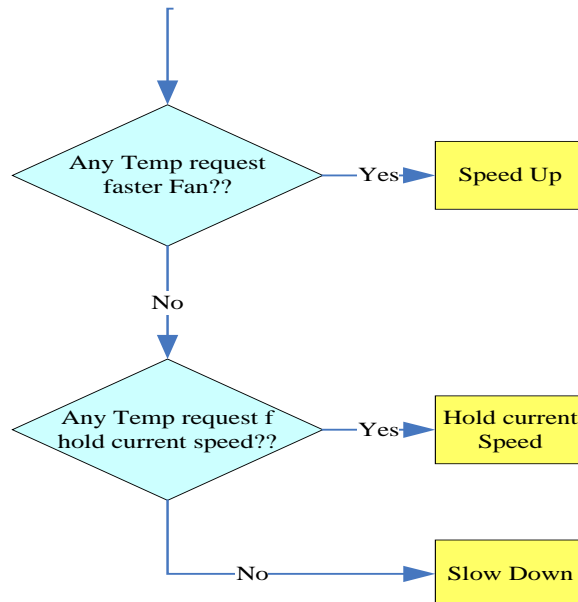

6.7.4 DTS (Sensor) Based Fan Control

NCT7904D fully follows Intel latest DTS Based Thermal Spec to come out an easy used fan speed control algorithm which has involved traditional thermal cruise mode concept. Users are supposed to have related document to capture Intel's concept.

The principle of DTS based fan control behavior will be described with the figure in the below. First of all, there are two mainly behaviors, which is distinguished by whether Tsensor is larger than Tcontrol_spec.

If Tcontrol_spec is larger than Tsensor, the fan control behavior will obey left plane and thermal cruise mode's Target_Temp is set as Target_Reg. Once Tsensor > Target_Reg, the fan out duty will continuously increases by one duty until Tsensor is under Target_Reg. In contrary, if Tsensor < (Target_Reg - Tolerance), the fan out duty will continuously decreases by one duty until Tsensor is over (Target_Reg - Tolerance).

If Tcontrol_spec is smaller than Tsensor, the fan control behavior will obey right plane and thermal cruise mode's Target_Temp is set as TDTS which just is Intel's DTS thermal profile. Once Tsensor > TDTS, the fan out duty will continuously increases by (1+|M|) duty until Tsensor is under TDTS. The symbol of M represents "Margin". It could be provided by NCT7904D itself. In contrary, if Tsensor < (TDTS - Tolerance), the fan out duty will continuously decreases by (1+|M|) duty until Tsensor is over (TDTS - Tolerance).

For both of plane, the gray region means that the fan out duty is unchanged at this moment.

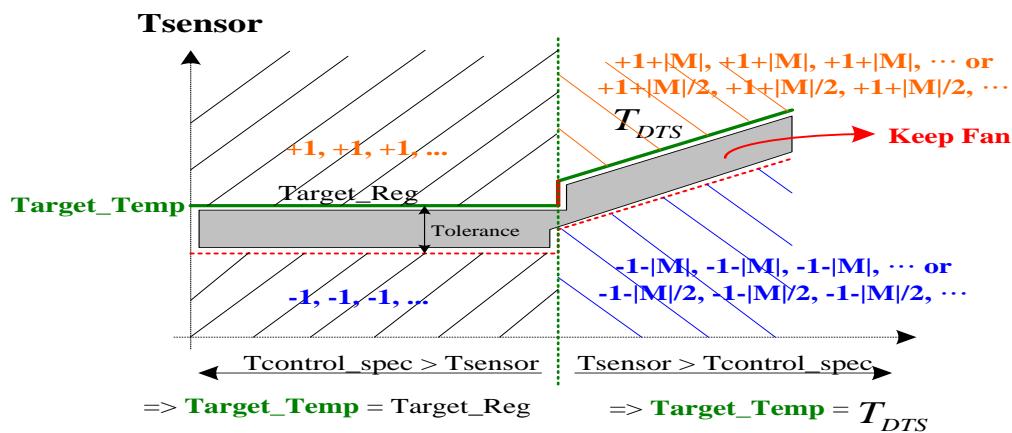

Thermal Cruise Mode

6.8 PECI

PECI (Platform Environment Control Interface) is a new digital interface to read plentiful information of Intel® CPUs. With a bandwidth ranging from 2 Kbps to 2 Mbps, PECI uses a single wire for self-clocking and data transfer.

6.8.1 Operation Mode

NCT7904D provides two operation modes. One is active mode, the other is passive.

For active mode, NCT7904D serves as a host to initiate a message transaction. NCT7904D provides automatic polling procedure for CPU temperature, CPU power and DRAM temperature. These thermal data could be continuously updated without any firmware intervention. In contrarily, except for what mentioned above, user still could write out or read in data to / from CPU by practicing manual commands which are pre-configured by external firmware.

In passive mode, NCT7904D just monitor the message over the PECI bus with silence and then only extract CPU's DTS thermal data for its fan speed control purpose.

6.8.2 CPU Temperature and Power Reporting

In NCT7904D, it supports CPU temperature and power reporting. And both of reading could be associated to NCT7904D's fan control algorithm.

For CPU temperature, by interfacing to the Digital Thermal Sensor (DTS) in the Intel® CPU, PECI reports a negative temperature (in counts) relative to the processor's temperature at which the thermal control circuit (TCC) is activated. At the TCC Activation temperature, the Intel CPU will operate at reduced performance to prevent the device from thermal damage.

The PECI temperature values returning from the CPU are in "counts" which are approximately linear in relation to changes in temperature in degrees centigrade. However, this linearity is approximate and cannot be guaranteed over the entire range of PECI temperatures. For further information, refer to the PECI specification. However NCT7904D has a biasing factor for customer to characterize the relation between "counts" and "temperature".

Figure A shows a typical fan speed (PWM duty cycle) and PECI temperature relationship. SMART FAN™ IV

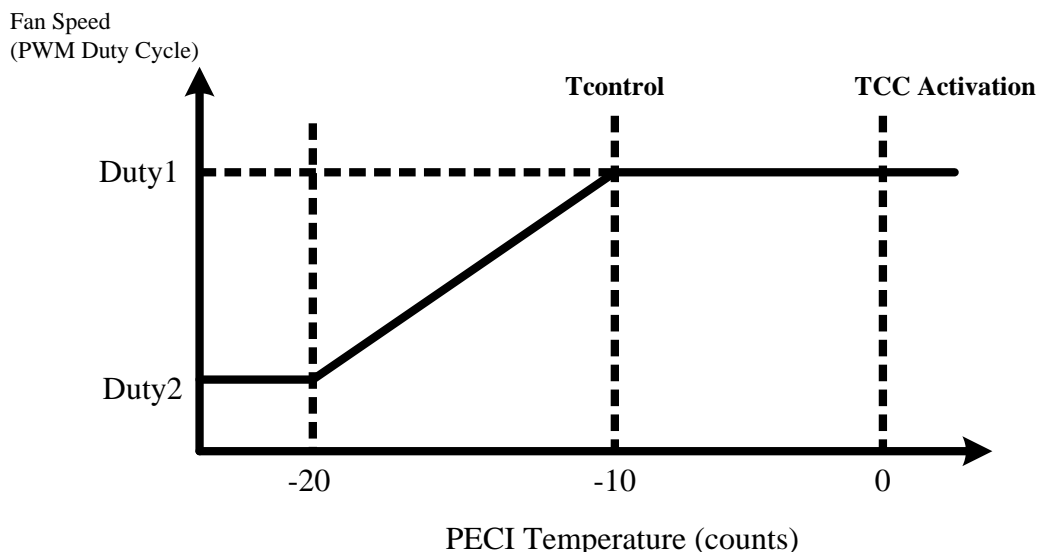

Fig. A PECI Temperature

In this illustration, when PECE temperature is -20, the PWM duty cycle for fan control is at Duty2. When CPU is getting hotter and the PECE temperature is -10, the PWM duty cycle is at Duty1.

At Tcontrol PECE temperature, the recommendation from Intel is to operate the CPU fan at full speed. Therefore Duty1 is 100% if this recommendation is followed. The value of Tcontrol can be obtained by reading the related Machine Specific Register (MSR) in the Intel CPU. The Tcontrol MSR address is usually in the BIOS Writer's guide for the CPU family in question. Refer to the relevant CPU documentation from Intel for more information. In this example, Tcontrol is -10.

When the PECE temperature is below -20, the duty cycle is fixed at Duty2 to maintain a minimum (and constant) RPM for the CPU fan.

For CPU power reporting, the NCT7904D routinely retrieves CPU energy and then convert it to power. The refreshing rate of power is 0.3 sec. In order to minimize the effect of suddenly huge power changing, the running time average algorithm has been implemented.

6.8.3 DRAM Thermal Data Reporting

NCT7904D can automatically report all 24 DIMMs thermal status which are provided by Intel CPU0 and CPU1 agent. In addition to each DIMM temperature, NCT7904D also records the highest DIMM temperature in the specific channel. Here is the relationship among CPU, Channel and DIMM.

Both the Channel Index<2:0> and DIMM Index<5:3> follow PECE3.0 RdPkgConfig() command format.

Agent Address	Channel_Index<2:0>	DIMM Index<5:3>	Register Location
CPU0_30h	Channel_0	DIMM_0	T_D0C0_C0
		DIMM_1	T_D1C0_C0
		DIMM_2	T_D2C0_C0
	Channel_1	DIMM_0	T_D0C1_C0
		DIMM_1	T_D1C1_C0
		DIMM_2	T_D2C1_C0
	Channel_2	DIMM_0	T_D0C2_C0
		DIMM_1	T_D1C2_C0
		DIMM_2	T_D2C2_C0
	Channel_3	DIMM_0	T_D0C2_C0
		DIMM_1	T_D1C2_C0
		DIMM_2	T_D2C2_C0
CPU1_31h	Channel_0	DIMM_0	T_D0C0_C1
		DIMM_1	T_D1C0_C1
		DIMM_2	T_D2C0_C1
	Channel_1	DIMM_0	T_D0C1_C1
		DIMM_1	T_D1C1_C1
		DIMM_2	T_D2C1_C1
	Channel_2	DIMM_0	T_D0C2_C1
		DIMM_1	T_D1C2_C1
		DIMM_2	T_D2C2_C1

Agent Address	Channel_Index<2:0>	DIMM Index<5:3>	Register Location
	Channel_3	DIMM_0	T_D0C3_C1
		DIMM_1	T_D1C3_C1
		DIMM_2	T_D2C3_C1

6.8.4 PECE Listening

It provides another way to obtain CPU's DTS thermal data. NCT7904D only recognizes GetTemp() command. Once GetTemp() appears on PECE bus and entire message is without FCS error, the CPU's DTS temperature will be extracted and recorded. These data could be temperature source of fan speed control.

6.9 SMI# Output

6.9.1 Temperature

SMI# for temperature monitoring provides 3 modes.

6.9.1.1. Comparator Interrupt Mode

Temperature exceeding $T_{warning}$ causes an interrupt and this interrupt will be reset when reading all of the Interrupt Status Registers. Once an interrupt event has occurred by exceeding $T_{warning}$, then reset, if the temperature remains above the $T_{warning}$ Hysteresis, the interrupt will occur again when the next conversion has completed. If an interrupt event has occurred by exceeding $T_{warning}$ and not reset, the interrupts will not occur again. The interrupts will continue to occur in this manner until the temperature goes below $T_{warning}$ Hysteresis.

6.9.1.2. Two-Times Interrupt Mode

Temperature exceeding $T_{critical}$ / $T_{warning}$ causes an interrupt and then temperature going below $T_{critical}$ Hysteresis / $T_{warning}$ Hysteresis will also cause an interrupt if the previous interrupt has been reset by reading all the Interrupt Status Register. Once an interrupt event has occurred by exceeding $T_{critical}$ / $T_{warning}$, then reset, if the temperature remains above the $T_{critical}$ Hysteresis / $T_{warning}$ Hysteresis, the interrupt will not occur.

6.9.1.3. One-Time Interrupt Mode

Temperature exceeding $T_{critical}$ / $T_{warning}$ causes an interrupt and then temperature going below $T_{critical}$ Hysteresis / $T_{warning}$ Hysteresis will not cause an interrupt. Once an interrupt event has occurred by exceeding $T_{critical}$ / $T_{warning}$, then going below $T_{critical}$ Hysteresis / $T_{warning}$ Hysteresis, an interrupt will not occur again until the temperature exceeding $T_{critical}$ / $T_{warning}$.

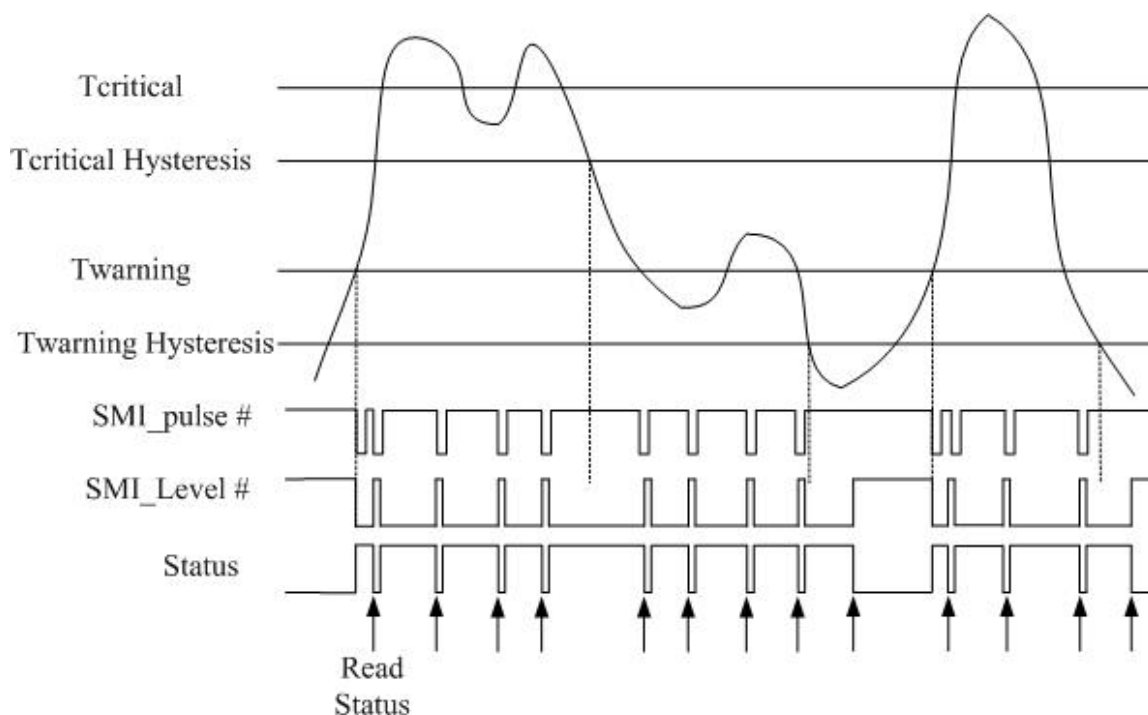

SMI comparator mode

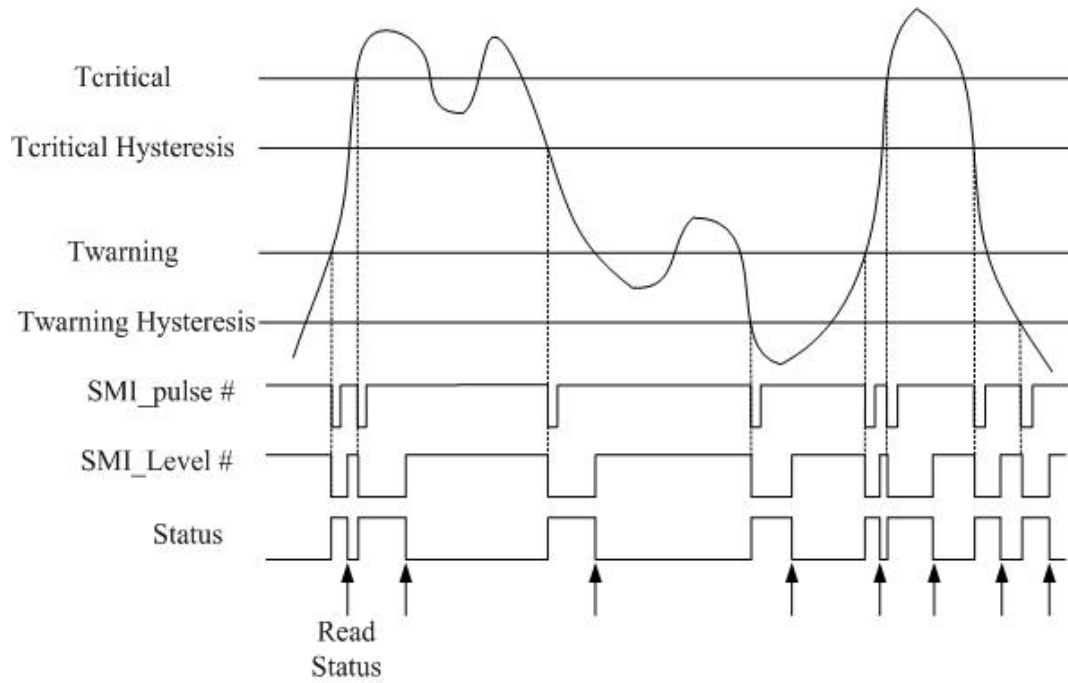

SMI two time mode

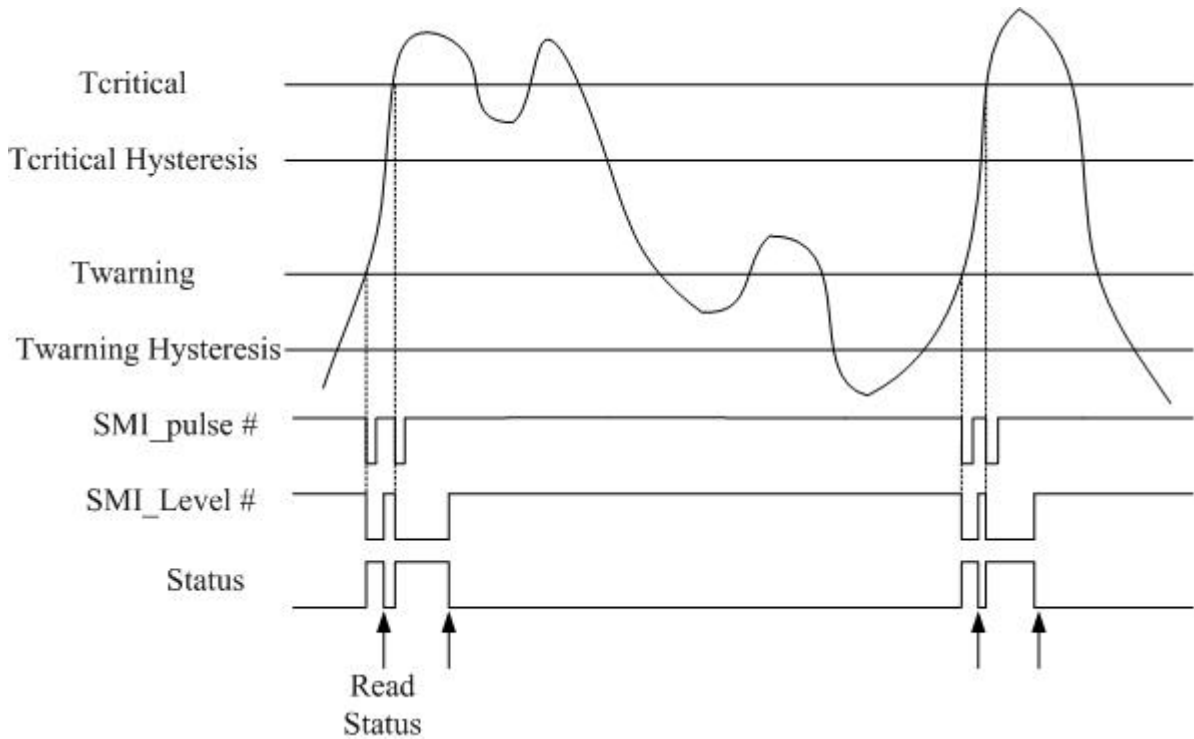

SMI one time mode

6.9.2 Voltage

SMI# interrupt for voltage is Two-Times Interrupt Mode. Voltage exceeds high limit or going below low limit, it will causes an interrupt if the previous interrupt has been reset by reading all the interrupt Status Register.

6.9.3 Fan

SMI# interrupt for fan is Two-Times Interrupt Mode. Fan count exceeds the limit, or exceeding and then going below the limit, it will cause an interrupt if the previous interrupt has been reset by reading all the interrupt Status Register.

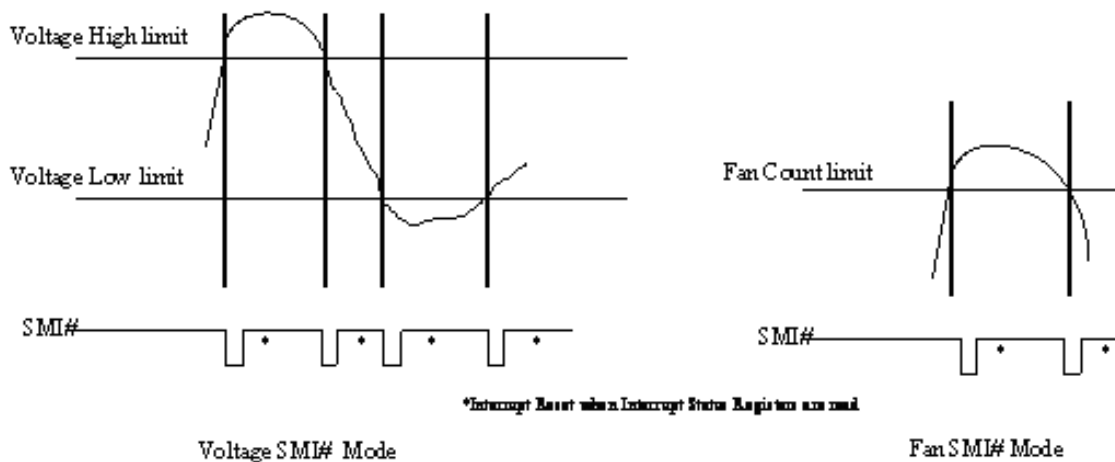

6.10 EEPROM Self-Initialization

6.10.1 EEPROM Format

The content of the EEPROM can be loaded to the registers of NCT7904D for self-initialization should obey this data format.

An example for Default Fan Speed set to FF(hex) in bank 2 :

Address	Data	Example
00h	ID_1	79h
01h	ID_2	61h
02h	Register Address 1	FFh
03h	Register Data 1	02h
04h	Register Address 2	04h
05h	Register Data 2	FFh
...
...
	ID_1	79h
	ID_2	61h

6.10.2 Chip Initialization

When NCT7904D detects power-on-reset, initialization process will start loading data from EEPROM. NCT7904D SMBUS (M_SMB_CLK, M_SMB_DATA) will be a master and issue consecutive read byte commands (EEPROM address is A0h). NCT7904D will check receive data to decide that which actions should be followed.

Case 1 : No acknowledge in first transaction, NCT7904D will terminate the initialization process to normal. And set LD_FAIL and LD_FINISH to 1 to note host the load status.

Case 2 : NCT7904D will check first two bytes by ID_1 and ID_2. If match, the process will continue. Otherwise, the process will terminate like Case 1.

Case 3 : Two bytes as a unit. NCT7904D will see first as the address of the register and second as the data. Sequentially, NCT7904D will write the data to the specific address.

Case 4 : When receiving the unit which store the data (ID_2 following ID_1), NCT7904D will stop initialization and back to normal and set LD_FAIL to 0 and LD_FINISH to 1 to note host the load status. Otherwise, the access will keep going.

The EEPROM loading would be started from NCT7904D power-on immediately, when implements the EEPROM self-initialization, the requested 3VSB power rising time must less than 60uS.

Note:

1. LD_FAIL and LD_FINISH are in address 00h in bank 0.

6.11 PCH Thermal Data Report

6.11.1 PCH Thermal Read

When enable PCH read function (set EN_PCH_RD to 1), NCT7904D SMBUS (M_SMB_CLK, M_SMB_DATA) will be a master and issue consecutive block read commands (PCH address can be configuration). NCT7904D will store the received data to the registers (F0h~FDh in bank 0) by PCH data format.

6.11.2 PCH Thermal Data Format

The PCH Thermal data may appear in either Byte 0 or Byte 1 depending on the specific ME firmware in use. Please contact Intel directly for information on your specific ME Firmware implementation.

6.12 SMBus Master Auto Read External Thermal Sensor

6.12.1 External Thermal Sensor Setting

Before using this function, there are several registers must be set:

1. Configuration external sensor SMBus address and command where temperature store in. (6Ch ~ 73h in bank 2).
2. Set relative port enable and enable external temperature read (6Ah in bank 2).

6.12.2 Temperature Read Process

After proper setting, NCT7904D will auto read, by setting, external sensor temperature from SMBus master I/F. The read temperature will be stored in the registers (BCh ~ BFh in bank 0), respectively. These temperatures can be the sources of the fan controller in NCT7904D. Any not enable port can normally be the virtual temperature simply written by host to do advanced fan control.

6.13 PROCHOT# Behavior

6.13.1 PROCHOT# Input

When enable PROCHOT# input monitor function (set EN_PH1 to 1 in bank 0, PH1_MD to 1 in bank 1), NCT7904D will monitor P1_PROCHOT# pin, count the time between two falling edge as P1_PROCHOT#_DVAL[7:0] and the time between one rising edge to one falling edge P1_PROCHOT#_NVAL[7:0], and stores these two to the registers. System management can monitor these two values to know the thermal status for relative CPU. The timer to the counter is settable from register, and the default is 22us.

6.13.2 PROCHOT# Output

When enable PROCHOT# output function (set EN_PH1 to 1 in bank 0, PH1_MD to 0 in bank 1), NCT7904D will drive low to P1_PROCHOT# pin based on several thermal events over heat.

There are three temperature sources listed as blow,

Source 1 : 4 remote temperature inputs or build-in thermal diode temperature

Source 2 : Up to 8 CPU temperatures

Source 3 : Up to 4 CPU Powers (by PECI)

The frequency and duty cycle of PROCHOT# output are settable by PH1_FSEL[1:0] and PH1_DC[3:0], respectively.

6.14 LED Behavior

6.14.1 Event Trigger LED

When enable LED function (set EN_E_LED to 1), NCT7904D will detect LED_EVNT_IN# pin as the drive condition for LED_OUT. LED pin will be float when LED_EVNT_IN# pin is detected high, and LED pin will drive low when LED_EVNT_IN# is detected low. LED driving low frequency and polarity can be settable.

6.14.2 Programmable LED

When enable programmable LED function (set EN_P_LED to 1), NCT7904D will drive register data P_LED_DATA to LED pin. Drive low frequency and polarity can be settable.

6.15 BEEP Function

6.15.1 Output Signaling

Output signaling for BEEP is controlled by an internal signal mixer. The baseband signal is a period signal which is at frequency 1Hz with duty cycle 50% (i.e. the period for high and low level is 500ms.) The high level of the baseband signal will mix the signal which is at frequency 700Hz with duty cycle 50%, and the low level of the baseband signal will mix the signal which is at frequency 350Hz with duty cycle 50%, causing the ambulance sound for alarm to users.

6.15.2 BEEP Activation

When enable BEEP function (set EN_BEEP to 1), NCT7904D will drive the signal to BEEP pin when BEEP sources selected and over limitation. Otherwise, NCT7904D will float the pin. The sources are defined in relative registers.

6.16 THERMTRIP# Function

6.16.1 Power by VSB

When enable THERMTRIP function (set EN_THRM to 1), NCT7904D will detect low and log the signal to THRM_STS register. The THRM_STS register will be cleared by setting the CLR_THRM register to 1 and the CLR_THRM will be auto cleared.

6.16.2 Power Only by VBAT

NCT7904D will keep the THRM_STS register when VBAT power-on, losing the data when VBAT power-off.

7. REGISTER DESCRIPTION

7.1 Bank 0 REGISTER DETAIL

7.1.1 Global Control Register

Location: Bank 0 Address 00_{HEX}

Type: Read/Write

Reset: Power On Reset

Default Value: 01_{HEX}

BIT	DESCRIPTION
7	INIT_RST Registers initial reset (Auto be cleared when reset process completed)
6	Reserved
5	LD_FAIL 0 = EEPROM present and no error happened 1 = EEPROM not present or error happened
4	LD_FINISH 0 = EEPROM data load processing 1 = EEPROM data load finished
3	LOCK 0 = RESETIN# will reset registers 1 = RESETIN# will not reset registers (This bit will be also cleared when set INIT_RST)
2	Reserved
1-0	CLKIN_SEL[1:0] 00 _{BIN} = 14.318MHz 01 _{BIN} = 33MHz (default) 10 _{BIN} = 48MHz 11 _{BIN} = Reserved

7.1.2 SMB Slave Address Register

Location: Bank 0 Address 0C_{HEX}

Type: Read Only

Reset: Power On Reset

Default Value: 5A_{HEX}/5C_{HEX}

BIT	DESCRIPTION
7-0	SMB_SLV_ADDR[7:0] 5A _{HEX} = ADDR pin strapped low 5C _{HEX} = ADDR pin strapped high

7.1.3 Nuvoton Vendor ID Register

Location: Bank 0 Address 0D_{HEX}

Type: Read Only

Reset: Power On Reset

Default Value: 50_{HEX}

BIT	DESCRIPTION
7-0	VENDOR_ID[7:0]

7.1.4 Nuvoton Chip ID Register

Location: Bank 0 Address 0E_{HEX}

Type: Read Only

Reset: Power On Reset

Default Value: C5_{HEX}

BIT	DESCRIPTION
7-0	CHIP_ID[7:0]

7.1.5 Nuvoton Device ID Register

Location: Bank 0 Address 0F_{HEX}

Type: Read Only

Reset: Power On Reset

Default Value: 5x_{HEX}

BIT	DESCRIPTION
7-0	DEVICE_ID[7:0]

7.1.6 Programmable LED Register

Location: Bank 0 Address 18_{HEX}

Type: Read / Write

Reset: Power On Reset
RESETIN# with LOCK=0

Default Value: 00_{HEX}

BIT	DESCRIPTION
7	EN_P_LED 0 = Disable 1 = Enable
6	P_LED_POL 0 = LED output active low 1 = LED output active high
5	P_LED_DATA 0 = Output don't drive 1 = Output drive
4-3	Reserved
2-0	P_LED_FSEL[2:0]

BIT	DESCRIPTION
	000 _{BIN} = 4Hz 001 _{BIN} = 2Hz 010 _{BIN} = 1Hz 011 _{BIN} = 0.5Hz 100 _{BIN} = 0.25Hz 101 _{BIN} = 0.125Hz 110 _{BIN} = 0.0625Hz 111 _{BIN} = 0Hz

7.1.7 Event Control LED Register

Location: Bank 0 Address 19_{HEX}

Type: Read / Write

Reset: Power On Reset
RESETIN# with LOCK=0

Default Value: 00_{HEX}

BIT	DESCRIPTION
7	EN_E_LED 0 = Disable 1 = Enable (LED_OUT will controlled by LED_EVNT_IN#)
6	E_LED_POL 0 = LED output active low 1 = LED output active high
5-3	Reserved
2-0	E_LED_FSEL[2:0] 000 _{BIN} = 4Hz 001 _{BIN} = 2Hz 010 _{BIN} = 1Hz 011 _{BIN} = 0.5Hz 100 _{BIN} = 0.25Hz 101 _{BIN} = 0.125Hz 110 _{BIN} = 0.0625Hz 111 _{BIN} = 0Hz

7.1.8 Monitor Enable Control Register

Location:

- VT_ADC_CTRL0** - Bank 0 Address 20_{HEX}
- VT_ADC_CTRL1** - Bank 0 Address 21_{HEX}
- VT_ADC_CTRL2** - Bank 0 Address 22_{HEX}
- PH_CTRL0** - Bank 0 Address 23_{HEX}
- FANIN_CTRL0** - Bank 0 Address 24_{HEX}
- FANIN_CTRL1** - Bank 0 Address 25_{HEX}
- DTS_T_CTRL0** - Bank 0 Address 26_{HEX}
- DTS_T_CTRL1** - Bank 0 Address 27_{HEX}
- DTS_P_CTRL0** - Bank 0 Address 28_{HEX}

Type: Read / Write
 Reset: Power On Reset
 RESETIN# with LOCK=0

VT_ADC_CTRL0 – Voltage Temperature Monitoring Control Register

Location: Bank 0 Address 20_{HEX}

Default Value: FF_{HEX}

BIT	DESCRIPTION
7	EN_VSEN8 – Enable VSEN8 voltage monitoring. 0 = Disable 1 = Enable
6	EN_VSEN7 – Enable VSEN7 voltage monitoring. 0 = Disable 1 = Enable
5	EN_VSEN6 – Enable VSEN6 voltage monitoring. 0 = Disable 1 = Enable
4	EN_VSEN5 – Enable VSEN5 voltage monitoring. 0 = Disable 1 = Enable
3	EN_VSEN4 – Enable VSEN4 voltage monitoring. 0 = Disable 1 = Enable
2	EN_VSEN3 – Enable VSEN3 voltage monitoring. 0 = Disable 1 = Enable
1	EN_VSEN2 – Enable VSEN2 voltage monitoring. 0 = Disable 1 = Enable
0	EN_VSEN1 – Enable VSEN1 voltage monitoring. 0 = Disable 1 = Enable

VT_ADC_CTRL1 – Voltage Temperature Monitoring Control Register

Location: Bank 0 Address 21_{HEX}

Default Value: 7F_{HEX}

BIT	DESCRIPTION
7	EN_VBAT – Enable VBAT voltage monitoring. 0 = Disable 1 = Enable
6	EN_3VDD – Enable 3VDD voltage monitoring. 0 = Disable 1 = Enable
5	EN_VSEN14 – Enable VSEN14 voltage monitoring. 0 = Disable

BIT	DESCRIPTION
	1 = Enable
4	EN_VSEN13 – Enable VSEN13 voltage monitoring. 0 = Disable 1 = Enable
3	EN_VSEN12 – Enable VSEN12 voltage monitoring. 0 = Disable 1 = Enable
2	EN_VSEN11 – Enable VSEN11 voltage monitoring. 0 = Disable 1 = Enable
1	EN_VSEN10 – Enable VSEN10 voltage monitoring. 0 = Disable 1 = Enable
0	EN_VSEN9 – Enable VSEN9 voltage monitoring. 0 = Disable 1 = Enable

VT_ADC_CTRL2 – Voltage Temperature Monitoring Control Register

Location: Bank 0 Address 22_{HEX}

Default Value: 03_{HEX}

BIT	DESCRIPTION
7-5	Reserved
4	EN_VSEN19 – Enable VSEN19 voltage monitoring. 0 = Disable (This pin will change to PWM4/DCOUT) 1 = Enable
3	EN_VSEN18 – Enable VSEN18 voltage monitoring. 0 = Disable (This pin will change to PWM3) 1 = Enable
2	EN_VSEN17 – Enable VSEN17 voltage monitoring. 0 = Disable (This pin will change to WDT_RSTOUT#/GPIOG) 1 = Enable
1	EN_LTD – Enable local temperature monitoring. 0 = Disable 1 = Enable
0	EN_V3VSB – Enable V3VSB voltage monitoring. 0 = Disable 1 = Enable

PH_CTRL0 – PROCHOT Monitoring Control Register

Location: Bank 0 Address 23_{HEX}

Default Value: 01_{HEX}

BIT	DESCRIPTION
7-1	Reserved
0	EN_PH1 – Enable P1_PROCHOT# monitoring. 0 = Disable 1 = Enable

FANIN_CTRL0 – FANIN Monitoring Control Register

Location: Bank 0 Address 24_{HEX}

Default Value: FF_{HEX}

BIT	DESCRIPTION
7	EN_FANIN_8 – Enable FANIN_8 monitoring. 0 = Disable 1 = Enable
6	EN_FANIN_7 – Enable FANIN_7 monitoring. 0 = Disable 1 = Enable
5	EN_FANIN_6 – Enable FANIN_6 monitoring. 0 = Disable 1 = Enable
4	EN_FANIN_5 – Enable FANIN_5 monitoring. 0 = Disable 1 = Enable
3	EN_FANIN_4 – Enable FANIN_4 monitoring. 0 = Disable 1 = Enable
2	EN_FANIN_3 – Enable FANIN_3 monitoring. 0 = Disable 1 = Enable
1	EN_FANIN_2 – Enable FANIN_2 monitoring. 0 = Disable 1 = Enable
0	EN_FANIN_1 – Enable FANIN_1 monitoring. 0 = Disable 1 = Enable

FANIN_CTRL1 – FANIN Monitoring Control Register

Location: Bank 0 Address 25_{HEX}

Default Value: 03_{HEX}

BIT	DESCRIPTION
7-4	Reserved
3	EN_FANIN_12 – Enable FANIN_12 monitoring. 0 = Disable 1 = Enable
2	EN_FANIN_11 – Enable FANIN_11 monitoring. 0 = Disable 1 = Enable
1	EN_FANIN_10 – Enable FANIN_10 monitoring. 0 = Disable 1 = Enable
0	EN_FANIN_9 – Enable FANIN_9 monitoring. 0 = Disable 1 = Enable

DTS_T_CTRL0 – Digital Temperature Monitoring Control Register

Location: Bank 0 Address 26_{HEX}

Default Value: 0F_{HEX}

BIT	DESCRIPTION
7-4	Reserved
3	EN_TCPU4 – Enable DTS CPU4 temperature monitoring (PECI/TSI). 0 = Disable 1 = Enable
2	EN_TCPU3 – Enable DTS CPU3 temperature monitoring (PECI/TSI). 0 = Disable 1 = Enable
1	EN_TCPU2 – Enable DTS CPU2 temperature monitoring (PECI/TSI). 0 = Disable 1 = Enable
0	EN_TCPU1 – Enable DTS CPU1 temperature monitoring (PECI/TSI). 0 = Disable 1 = Enable

DTS_T_CTRL1 – Digital Temperature Monitoring Control Register

Location: Bank 0 Address 27_{HEX}

Default Value: 0F_{HEX}

BIT	DESCRIPTION
7-4	Reserved
3	EN_TCPU8 – Enable DTS CPU8 temperature monitoring (TSI). 0 = Disable 1 = Enable
2	EN_TCPU7 – Enable DTS CPU7 temperature monitoring (TSI).

BIT	DESCRIPTION
	0 = Disable 1 = Enable
1	EN_TCPU6 – Enable DTS CPU6 temperature monitoring (TSI). 0 = Disable 1 = Enable
0	EN_TCPU5 – Enable DTS CPU5 temperature monitoring (TSI). 0 = Disable 1 = Enable

DTS_P_CTRL0 – Digital Power Monitoring Control Register

Location: Bank 0 Address 28_{HEX}

Default Value: 0F_{HEX}

BIT	DESCRIPTION
7-4	Reserved
3	EN_PCPU4 – Enable DTS CPU4 power monitoring (PECI). 0 = Disable 1 = Enable
2	EN_PCPU3 – Enable DTS CPU3 power monitoring (PECI). 0 = Disable 1 = Enable
1	EN_PCPU2 – Enable DTS CPU2 power monitoring (PECI). 0 = Disable 1 = Enable
0	EN_PCPU1 – Enable DTS CPU1 power monitoring (PECI). 0 = Disable 1 = Enable

7.1.9 Monitor Configuration Register

Location:

- VT_ADC_VOL_PO** - Bank 0 Address 2C_{HEX}
- VT_ADC_LTD_PO** - Bank 0 Address 2D_{HEX}
- VT_ADC_MD** - Bank 0 Address 2E_{HEX}
- VT_ADC_PO0** - Bank 0 Address 2F_{HEX}
- VT_ADC_PO1** - Bank 0 Address 30_{HEX}
- VT_ADC_PO2** - Bank 0 Address 31_{HEX}
- VT_ADC_PO3** - Bank 0 Address 32_{HEX}

Type: Read / Write

Reset: Power On Reset
RESETIN# with LOCK=0

VT_ADC_VOL_PO – Voltage Post Offset Register

Location: Bank 0 Address 2C_{HEX}

Default Value: 00_{HEX}

BIT	DESCRIPTION
7-0	VT_ADC_VOL_PO[7:0] Post offset adjustment in voltage

VT_ADC_LTD_PO – LTD Temperature Post Offset Register

Location: Bank 0 Address 2D_{HEX}

Default Value: 00_{HEX}

BIT	DESCRIPTION
7-0	VT_ADC_LTD_PO[7:0] Post offset adjustment in LTD temperature

VT_ADC_MD – Voltage Temperature Mode Control Register

Location: Bank 0 Address 2E_{HEX}

Default Value: 00_{HEX}

BIT	DESCRIPTION
7-6	VSEN89_MD[1:0] 00 _{BIN} = Voltage monitoring 01 _{BIN} = Reserved 10 _{BIN} = Reserved 11 _{BIN} = Temperature monitoring (thermistor) When set to thermistor mode, the Pin.8 will be TR4 function, the Pin.9 will be VSEN9 function.
5-4	VSEN67_MD[1:0] 00 _{BIN} = Voltage monitoring 01 _{BIN} = Reserved 10 _{BIN} = Reserved 11 _{BIN} = Temperature monitoring (thermistor) When set to thermistor mode, the Pin.6 will be TR3 function, the Pin.7 will be VSEN7 function.
3-2	VSEN45_MD[1:0] 00 _{BIN} = Voltage monitoring 01 _{BIN} = Temperature monitoring (thermal diode current mode) 10 _{BIN} = Reserved 11 _{BIN} = Temperature monitoring (thermistor) When set to thermistor mode, the Pin.4 will be TR2 function, the Pin.5 will be VSEN5 function.
1-0	VSEN23_MD[1:0] 00 _{BIN} = Voltage monitoring 01 _{BIN} = Temperature monitoring (thermal diode current mode) 10 _{BIN} = Reserved 11 _{BIN} = Temperature monitoring (thermistor) When set to thermistor mode, the Pin.2 will be TR1 function, the Pin.3 will be VSEN3 function.

VT_ADC_PO0 – Voltage Temperature Post Offset Register

Location: Bank 0 Address 2F_{HEX}

Default Value: 00_{HEX}

BIT	DESCRIPTION
7-0	VSEN23_PO[7:0] Post offset adjustment when VSEN23_MD[1:0] in temperature mode

VT_ADC_PO1 – Voltage Temperature Post Offset Register

Location: Bank 0 Address 30_{HEX}

Default Value: 00_{HEX}

BIT	DESCRIPTION
7-0	VSEN45_PO[7:0] Post offset adjustment when VSEN45_MD[1:0] in temperature mode

VT_ADC_PO2 – Voltage Temperature Post Offset Register

Location: Bank 0 Address 31_{HEX}

Default Value: 00_{HEX}

BIT	DESCRIPTION
7-0	VSEN67_PO[7:0] Post offset adjustment when VSEN67_MD[1:0] in temperature mode

VT_ADC_PO3 – Voltage Temperature Post Offset Register

Location: Bank 0 Address 32_{HEX}

Default Value: 00_{HEX}

BIT	DESCRIPTION
7-0	VSEN89_PO[7:0] Post offset adjustment when VSEN89_MD[1:0] in temperature mode

7.1.10 Voltage Channel and Temperature Monitored Value Register

Location:

VSEN1_HV	- Bank 0 Address 40 _{HEX}
VSEN1_LV	- Bank 0 Address 41 _{HEX}
VSEN2_HV / TEMP_CH1_HV	- Bank 0 Address 42 _{HEX}
VSEN2_LV / TEMP_CH1_LV	- Bank 0 Address 43 _{HEX}
VSEN3_HV	- Bank 0 Address 44 _{HEX}
VSEN3_LV	- Bank 0 Address 45 _{HEX}
VSEN4_HV / TEMP_CH2_HV	- Bank 0 Address 46 _{HEX}
VSEN4_LV / TEMP_CH2_LV	- Bank 0 Address 47 _{HEX}
VSEN5_HV	- Bank 0 Address 48 _{HEX}
VSEN5_LV	- Bank 0 Address 49 _{HEX}
VSEN6_HV / TEMP_CH3_HV	- Bank 0 Address 4A _{HEX}
VSEN6_LV / TEMP_CH3_LV	- Bank 0 Address 4B _{HEX}
VSEN7_HV	- Bank 0 Address 4C _{HEX}
VSEN7_LV	- Bank 0 Address 4D _{HEX}
VSEN8_HV / TEMP_CH4_HV	- Bank 0 Address 4E _{HEX}
VSEN8_LV / TEMP_CH4_LV	- Bank 0 Address 4F _{HEX}
VSEN9_HV	- Bank 0 Address 50 _{HEX}
VSEN9_LV	- Bank 0 Address 51 _{HEX}
VSEN10_HV	- Bank 0 Address 52 _{HEX}
VSEN10_LV	- Bank 0 Address 53 _{HEX}
VSEN11_HV	- Bank 0 Address 54 _{HEX}
VSEN11_LV	- Bank 0 Address 55 _{HEX}
VSEN12_HV	- Bank 0 Address 56 _{HEX}
VSEN12_LV	- Bank 0 Address 57 _{HEX}
VSEN13_HV	- Bank 0 Address 58 _{HE}
VSEN13_LV	- Bank 0 Address 59 _{HEX X}
VSEN14_HV	- Bank 0 Address 5A _{HEX}
VSEN14_LV	- Bank 0 Address 5B _{HEX}
3VDD_HV	- Bank 0 Address 5C _{HEX}
3VDD_LV	- Bank 0 Address 5D _{HEX}
VBAT_HV	- Bank 0 Address 5E _{HEX}
VBAT_LV	- Bank 0 Address 5F _{HEX}
V3VSB_HV	- Bank 0 Address 60 _{HEX}
V3VSB_LV	- Bank 0 Address 61 _{HEX}
LTD_HV	- Bank 0 Address 62 _{HEX}
LTD_LV	- Bank 0 Address 63 _{HEX}
VSEN17_HV	- Bank 0 Address 64 _{HEX}
VSEN17_LV	- Bank 0 Address 65 _{HEX}
VSEN18_HV	- Bank 0 Address 66 _{HEX}
VSEN18_LV	- Bank 0 Address 67 _{HEX}
VSEN19_HV	- Bank 0 Address 68 _{HEX}
VSEN19_LV	- Bank 0 Address 69 _{HEX}

Type: Read Only
 Reset: Power On Reset

VOLTAGE HIGH VALUE

BIT	7	6	5	4	3	2	1	0
NAME	Voltage High Value 11-bit voltage value bit[10:3]							

VOLTAGE LOW VALUE

BIT	7	6	5	4	3	2	1	0
NAME	Reserved					Voltage Low Value 11-bit voltage value bit[2:0]		

TEMPERATURE HIGH VALUE

BIT	7	6	5	4	3	2	1	0
NAME	Temperature High Value. The real temperature value calculation is referred to Temperature Monitor Data Format description. 11-bit 2's complement bit[10:3]							
VALUE	SIGN	64	32	16	8	4	2	1

TEMPERATURE LOW VALUE

BIT	7	6	5	4	3	2	1	0
NAME	Reserved					Temperature Low Value 11-bit 2's complement bit[2:0]		
VALUE	Reserved					0.5	0.25	0.125

7.1.11 PROCHOT Monitored Value Register

Location: **P1_PH_NV** - Bank 0 Address 70_{HEX}
P1_PH_DV - Bank 0 Address 71_{HEX}

Type: Read Only
 Reset: Power On Reset

P1_PH_NV – CPU1 PROCHOT# Numerator Value Register

Location: Bank 0 Address 70_{HEX}
 Default Value: N/A

BIT	DESCRIPTION
7-0	P1_PROCHOT#_NVAL[7:0] CPU1 PROCHOT# Numerator Value

P1_PH_DV – CPU1 PROCHOT# Denominator Value Register

Location: Bank 0 Address 71_{HEX}
 Default Value: N/A

BIT	DESCRIPTION
7-0	P1_PROCHOT#_DVAL[7:0] CPU1 PROCHOT# Denominator Value

7.1.12 Nuvoton Vendor ID Register

Location: Bank X Address 7A_{HEX}

Type: Read Only

Reset: Power On Reset

Default Value: 50_{HEX}

BIT	DESCRIPTION
7-0	VENDOR_ID[7:0] Duplicate of data found in Bank 0 Address 0Dh. Data at Address 7Ah is available in all Bank Settings.

7.1.13 Nuvoton Chip ID Register

Location: Bank X Address 7B_{HEX}

Type: Read Only

Reset: Power On Reset

Default Value: C5_{HEX}

BIT	DESCRIPTION
7-0	CHIP_ID[7:0] Duplicate of data found in Bank 0 Address 0Eh. Data at Address 7Bh is available in all Bank Settings.

7.1.14 Nuvoton Device ID Register

Location: Bank X Address 7C_{HEX}

Type: Read Only

Reset: Power On Reset

Default Value: 5x_{HEX}

BIT	DESCRIPTION
7-0	DEVICE_ID[7:0] Duplicate of data found in Bank 0 Address 0Fh. Data at Address 7Ch is available in all Bank Settings.

7.1.15 FAN Tachometer Monitored Value Register

- Location: **FANIN1_HV** - Bank 0 Address 80_{HEX}
- FANIN1_LV** - Bank 0 Address 81_{HEX}
- FANIN2_HV** - Bank 0 Address 82_{HEX}
- FANIN2_LV** - Bank 0 Address 83_{HEX}
- FANIN3_HV** - Bank 0 Address 84_{HEX}
- FANIN3_LV** - Bank 0 Address 85_{HEX}
- FANIN4_HV** - Bank 0 Address 86_{HEX}
- FANIN4_LV** - Bank 0 Address 87_{HEX}
- FANIN5_HV** - Bank 0 Address 88_{HEX}
- FANIN5_LV** - Bank 0 Address 89_{HEX}
- FANIN6_HV** - Bank 0 Address 8A_{HEX}
- FANIN6_LV** - Bank 0 Address 8B_{HEX}
- FANIN7_HV** - Bank 0 Address 8C_{HEX}

- FANIN7_LV - Bank 0 Address 8D_{HEX}
- FANIN8_HV - Bank 0 Address 8E_{HEX}
- FANIN8_LV - Bank 0 Address 8F_{HEX}
- FANIN9_HV - Bank 0 Address 90_{HEX}
- FANIN9_LV - Bank 0 Address 91_{HEX}
- FANIN10_HV - Bank 0 Address 92_{HEX}
- FANIN10_LV - Bank 0 Address 93_{HEX}
- FANIN11_HV - Bank 0 Address 94_{HEX}
- FANIN11_LV - Bank 0 Address 95_{HEX}
- FANIN12_HV - Bank 0 Address 96_{HEX}
- FANIN12_LV - Bank 0 Address 97_{HEX}

Type: Read Only
 Reset: Power On Reset

FANIN HIGH VALUE

BIT	7	6	5	4	3	2	1	0
NAME	Fan Input Count High Value 13-bit fan count value bit[12:5]							

FANIN LOW VALUE

BIT	7	6	5	4	3	2	1	0
NAME	Reserved			Fan Input Count Low Value 13-bit fan count value bit[4:0]				

7.1.16 DTS Temperature Monitored Value Register

Location:

- T_CPU1_HV - Bank 0 Address A0_{HEX}
- T_CPU1_LV - Bank 0 Address A1_{HEX}
- T_CPU2_HV - Bank 0 Address A2_{HEX}
- T_CPU2_LV - Bank 0 Address A3_{HEX}
- T_CPU3_HV - Bank 0 Address A4_{HEX}
- T_CPU3_LV - Bank 0 Address A5_{HEX}
- T_CPU4_HV - Bank 0 Address A6_{HEX}
- T_CPU4_LV - Bank 0 Address A7_{HEX}
- T_CPU5_HV - Bank 0 Address A8_{HEX}
- T_CPU5_LV - Bank 0 Address A9_{HEX}
- T_CPU6_HV - Bank 0 Address AA_{HEX}
- T_CPU6_LV - Bank 0 Address AB_{HEX}
- T_CPU7_HV - Bank 0 Address AC_{HEX}
- T_CPU7_LV - Bank 0 Address AD_{HEX}
- T_CPU8_HV - Bank 0 Address AE_{HEX}
- T_CPU8_LV - Bank 0 Address AF_{HEX}
- P_CPU1 - Bank 0 Address B0_{HEX}
- P_CPU2 - Bank 0 Address B1_{HEX}
- P_CPU3 - Bank 0 Address B2_{HEX}
- P_CPU4 - Bank 0 Address B3_{HEX}

Type: Read/Write (Writable DTS Source Selection is host)
 Reset: Power On Reset

TEMPERATURE HIGH VALUE

BIT	7	6	5	4	3	2	1	0
NAME	Temperature High Value. The real temperature value calculation is referred to Temperature Monitor Data Format description. 11-bit 2's complement bit[10:3] (From PECL, TSI, or Host)							
VALUE	SIGN	64	32	16	8	4	2	1

TEMPERATURE LOW VALUE

BIT	7	6	5	4	3	2	1	0
NAME	Reserved					Temperature Low Value 11-bit 2's complement bit[2:0] (From PECL, TSI, or Host)		
VALUE	Reserved					0.5	0.25	0.125

P_CPU1 – CPU1 Power Value Register

Location: Bank 0 Address B0_{HEX}

Default Value: N/A

BIT	DESCRIPTION
7-0	POWER_CPU1[7:0] CPU1 Power Value (From PECL or Host)

P_CPU2 – CPU2 Power Value Register

Location: Bank 0 Address B1_{HEX}

Default Value: N/A

BIT	DESCRIPTION
7-0	POWER_CPU2[7:0] CPU2 Power Value (From PECL or Host)

P_CPU3 – CPU3 Power Value Register

Location: Bank 0 Address B2_{HEX}

Default Value: N/A

BIT	DESCRIPTION
7-0	POWER_CPU3[7:0] CPU3 Power Value (From PECL or Host)

P_CPU4 – CPU4 Power Value Register

Location: Bank 0 Address B3_{HEX}

Default Value: N/A

BIT	DESCRIPTION
7-0	POWER_CPU4[7:0] CPU4 Power Value (From PECl or Host)

7.1.17 Virtual Temperature Value Register

Location:

VRT_TEMP1_V - Bank 0 Address B8_{HEX}

VRT_TEMP2_V - Bank 0 Address B9_{HEX}

VRT_TEMP3_V - Bank 0 Address BA_{HEX}

VRT_TEMP4_V - Bank 0 Address BB_{HEX}

Type: Read / Write

Reset: Power On Reset

RESETIN# with LOCK=0

Default Value: 00_{HEX}

BIT	DESCRIPTION
7-0	VRT_TEMP1_V[7:0] Virtual Temperature 1 Value (It can be one of temperature sources for the FAN controller)

BIT	DESCRIPTION
7-0	VRT_TEMP2_V[7:0] Virtual Temperature 2 Value (It can be one of temperature sources for the FAN controller)

BIT	DESCRIPTION
7-0	VRT_TEMP3_V[7:0] Virtual Temperature 3 Value (It can be one of temperature sources for the FAN controller)

BIT	DESCRIPTION
7-0	VRT_TEMP4_V[7:0] Virtual Temperature 4 Value (It can be one of temperature sources for the FAN controller)

7.1.18 External and Virtual Temperature Value Register

Location:

- EXT_VRT_TEMP1_V** - Bank 0 Address BC_{HEX}
- EXT_VRT_TEMP2_V** - Bank 0 Address BD_{HEX}
- EXT_VRT_TEMP3_V** - Bank 0 Address BE_{HEX}
- EXT_VRT_TEMP4_V** - Bank 0 Address BF_{HEX}

Type: Read / Write

Reset: Power On Reset
 RESETIN# with LOCK=0

Default Value: 00_{HEX}

BIT	DESCRIPTION
7-0	EXT_VRT_TEMP1_V[7:0] External Temperature 1 or Virtual Temperature 5 Value (It can be one of temperature sources for the FAN controller)

BIT	DESCRIPTION
7-0	EXT_VRT_TEMP2_V[7:0] External Temperature 2 or Virtual Temperature 6 Value (It can be one of temperature sources for the FAN controller)

BIT	DESCRIPTION
7-0	EXT_VRT_TEMP3_V[7:0] External Temperature 3 or Virtual Temperature 7 Value (It can be one of temperature sources for the FAN controller)

BIT	DESCRIPTION
7-0	EXT_VRT_TEMP4_V[7:0] External Temperature 4 or Virtual Temperature 8 Value (It can be one of temperature sources for the FAN controller)

7.1.19 SMI Control Register

Location: Bank 0 Address C0_{HEX}

Type: Read / Write

Reset: Power On Reset
 RESETIN# with LOCK=0

Default Value: 10_{HEX}

BIT	DESCRIPTION
7	RTSACS. 0 = Read Interrupt status from <u>CRC1~CRCA</u> . (Default) 1 = Read real-time status from <u>CRC1~CRCA</u> .
6-5	Reserved.
4	SMI_MD. 0 = SMI# outputs low level signal and active high. 1 = SMI# outputs 200 us low pulse signal. (Default)
3-2	TEMP_SMI_MD. Temperature SMI Mode Select. 00_{BIN} = Comparator Interrupt Mode. (Default) 01_{BIN} = Two Time Interrupt Mode. 10_{BIN} = One Time Interrupt Mode. 11_{BIN} = Two Time Non-related Interrupt Mode.
1	EN_SMI. 0 = disable SMI# signal output. (Default) 1 = enable SMI# signal output.
0	SMI_POL. 0 = SMI# polarity follows SMI_MD. (Default) 1 = SMI# polarity is inverted.

7.1.20 SMI Status Register

Location:

- SMI_STS1** - Bank 0 Address C1_{HEX}
- SMI_STS2** - Bank 0 Address C2_{HEX}
- SMI_STS3** - Bank 0 Address C3_{HEX}
- SMI_STS4** - Bank 0 Address C4_{HEX}
- SMI_STS5** - Bank 0 Address C5_{HEX}
- SMI_STS6** - Bank 0 Address C6_{HEX}
- SMI_STS7** - Bank 0 Address C7_{HEX}
- SMI_STS8** - Bank 0 Address C8_{HEX}
- SMI_STS9** - Bank 0 Address C9_{HEX}
- SMI_STS10** - Bank 0 Address CA_{HEX}

Type: Read Only

Reset: Power On Reset

SMI_STS1

BIT	7	6	5	4	3	2	1	0
NAME	S_VSEN8	S_VSEN7	S_VSEN6	S_VSEN5	S_VSEN4	S_VSEN3	S_VSEN2	S_VSEN1
DEFAULT	0	0	0	0	0	0	0	0

SMI_STS2

BIT	7	6	5	4	3	2	1	0
NAME	S_VBAT	S_3VDD	S_VSEN1 4	S_VSEN1 3	S_VSEN1 2	S_VSEN1 1	S_VSEN1 0	S_VSEN9
DEFAULT	0	0	0	0	0	0	0	0

SMI_STS3

BIT	7	6	5	4	3	2	1	0
NAME	Reserved	Reserved	Reserved	S_VSEN1 9	S_VSEN1 8	S_VSEN1 7	S_LTD	S_V3VSB
DEFAULT	0	0	0	0	0	0	0	0

SMI_STS4

BIT	7	6	5	4	3	2	1	0
NAME	Reserved	Reserved	Reserved	Reserved	Reserved	Reserved	Reserved	S_PH1
DEFAULT	0	0	0	0	0	0	0	0

SMI_STS5

BIT	7	6	5	4	3	2	1	0
NAME	S_FANIN 8	S_FANIN 7	S_FANIN 6	S_FANIN 5	S_FANIN 4	S_FANIN 3	S_FANIN 2	S_FANIN 1
DEFAULT	0	0	0	0	0	0	0	0

SMI_STS6

BIT	7	6	5	4	3	2	1	0
NAME	Reserved	Reserved	Reserved	Reserved	S_FANIN 12	S_FANIN 11	S_FANIN 10	S_FANIN 9
DEFAULT	0	0	0	0	0	0	0	0

SMI_STS7

BIT	7	6	5	4	3	2	1	0
NAME	Reserved	Reserved	Reserved	Reserved	S_TCPU4	S_TCPU3	S_TCPU2	S_TCPU1
DEFAULT	0	0	0	0	0	0	0	0

SMI_STS8

BIT	7	6	5	4	3	2	1	0
NAME	Reserved	Reserved	Reserved	Reserved	S_TCPU8	S_TCPU7	S_TCPU6	S_TCPU5
DEFAULT	0	0	0	0	0	0	0	0

SMI_STS9

BIT	7	6	5	4	3	2	1	0
NAME	Reserved	Reserved	Reserved	Reserved	S_PCPU4	S_PCPU3	S_PCPU2	S_PCPU1
DEFAULT	0	0	0	0	0	0	0	0

SMI_STS10

BIT	7	6	5	4	3	2	1	0
NAME	Reserved	S_CHASSIS	Reserved	Reserved	S_TART4	S_TART3	S_TART2	S_TART1
DEFAULT	0	0	0	0	0	0	0	0

*TART: When the Smart fan is driving the fan in full speed over 3 minutes, the TART will be asserted.

7.1.21 SMI Mask Register

Location:

- SMI_MSK1** - Bank 0 Address CB_{HEX}
- SMI_MSK2** - Bank 0 Address CC_{HEX}
- SMI_MSK3** - Bank 0 Address CD_{HEX}
- SMI_MSK4** - Bank 0 Address CE_{HEX}
- SMI_MSK5** - Bank 0 Address CF_{HEX}
- SMI_MSK6** - Bank 0 Address D0_{HEX}
- SMI_MSK7** - Bank 0 Address D1_{HEX}
- SMI_MSK8** - Bank 0 Address D2_{HEX}
- SMI_MSK9** - Bank 0 Address D3_{HEX}
- SMI_MSK10** - Bank 0 Address D4_{HEX}

Type: Read / Write

Reset: Power On Reset
RESETIN# with LOCK=0

SMI_MSK1

BIT	7	6	5	4	3	2	1	0
NAME	M_VSEN 8	M_VSEN 7	M_VSEN 6	M_VSEN 5	M_VSEN 4	M_VSEN 3	M_VSEN 2	M_VSEN 1
DEFAULT	1	1	1	1	1	1	1	1

SMI_MSK2

BIT	7	6	5	4	3	2	1	0
NAME	M_VBAT	M_3VDD	M_VSEN 14	M_VSEN 13	M_VSEN 12	M_VSEN 11	M_VSEN 10	M_VSEN 9
DEFAULT	1	1	1	1	1	1	1	1

SMI_MSK3

BIT	7	6	5	4	3	2	1	0
NAME	Reserved	Reserved	Reserved	M_VSEN 19	M_VSEN 18	M_VSEN 17	M_LTD	M_V3VSB

DEFAULT	0	0	0	1	1	1	1	1
---------	---	---	---	---	---	---	---	---

SMI_MSK4

BIT	7	6	5	4	3	2	1	0
NAME	Reserved	Reserved	Reserved	Reserved	Reserved	Reserved	Reserved	M_PH1
DEFAULT	0	0	0	0	0	0	0	1

SMI_MSK5

BIT	7	6	5	4	3	2	1	0
NAME	M_FANIN 8	M_FANIN 7	M_FANIN 6	M_FANIN 5	M_FANIN 4	M_FANIN 3	M_FANIN 2	M_FANIN 1
DEFAULT	1	1	1	1	1	1	1	1

SMI_MSK6

BIT	7	6	5	4	3	2	1	0
NAME	Reserved	Reserved	Reserved	Reserved	M_FANIN 12	M_FANIN 11	M_FANIN 10	M_FANIN 9
DEFAULT	0	0	0	0	1	1	1	1

SMI_MSK7

BIT	7	6	5	4	3	2	1	0
NAME	Reserved	Reserved	Reserved	Reserved	M_TCPU 4	M_TCPU 3	M_TCPU 2	M_TCPU 1
DEFAULT	0	0	0	0	1	1	1	1

SMI_MSK8

BIT	7	6	5	4	3	2	1	0
NAME	Reserved	Reserved	Reserved	Reserved	M_TCPU 8	M_TCPU 7	M_TCPU 6	M_TCPU 5
DEFAULT	0	0	0	0	1	1	1	1

SMI_MSK9

BIT	7	6	5	4	3	2	1	0
NAME	Reserved	Reserved	Reserved	Reserved	M_PCPU 4	M_PCPU 3	M_PCPU 2	M_PCPU 1
DEFAULT	0	0	0	0	1	1	1	1

SMI_MSK10

BIT	7	6	5	4	3	2	1	0
NAME	CLR_CH ASSIS	M_CHAS SIS	Reserved	Reserved	M_TART4	M_TART3	M_TART2	M_TART1
DEFAULT	0	1	0	0	1	1	1	1

CLR_CHASSIS is clear chassis event. When write 1 , the internal chassis event will be cleared.
M_CHASSIS is mask chassis event. When set to 1 , the chassis SMI event will be masked.

7.1.22 Beep Control Register

Location: Bank 0 Address D6_{HEX}

Type: Read / Write

Reset: Power On Reset
RESETIN# with LOCK=0

Default Value: 00_{HEX}

BIT	DESCRIPTION
7	EN_BEEP 0 = Disable 1 = Enable
6	BEEP_WNC 0 = Temperature BEEP boundary is critical level (Default) 1 = Temperature BEEP boundary is warning level
5-0	Reserved

7.1.23 Beep Source Selection Register

Location:

BEEP_SEL1 - Bank 0 Address D7_{HEX}

BEEP_SEL 2 - Bank 0 Address D8_{HEX}

BEEP_SEL 3 - Bank 0 Address D9_{HEX}

BEEP_SEL 4 - Bank 0 Address DA_{HEX}

BEEP_SEL 5 - Bank 0 Address DB_{HEX}

BEEP_SEL 6 - Bank 0 Address DC_{HEX}

BEEP_SEL 7 - Bank 0 Address DD_{HEX}

BEEP_SEL 8 - Bank 0 Address DE_{HEX}

BEEP_SEL 9 - Bank 0 Address DF_{HEX}

Type: Read / Write

Reset: Power On Reset
RESETIN# with LOCK=0

BEEP_SEL1

BIT	7	6	5	4	3	2	1	0
NAME	B_VSEN8	B_VSEN7	B_VSEN6	B_VSEN5	B_VSEN4	B_VSEN3	B_VSEN2	B_VSEN1
DEFAULT	0	0	0	0	0	0	0	0

BEEP_SEL2

BIT	7	6	5	4	3	2	1	0
NAME	B_VBAT	B_3VDD	B_VSEN1 4	B_VSEN1 3	B_VSEN1 2	B_VSEN1 1	B_VSEN1 0	B_VSEN9
DEFAULT	0	0	0	0	0	0	0	0

BEEP_SEL3

BIT	7	6	5	4	3	2	1	0
NAME	Reserved	Reserved	Reserved	B_VSEN1 9	B_VSEN1 8	B_VSEN1 7	B_LTD	B_V3VSB
DEFAULT	0	0	0	0	0	0	0	0

BEEP_SEL4

BIT	7	6	5	4	3	2	1	0
NAME	Reserved	Reserved	Reserved	Reserved	Reserved	Reserved	Reserved	B_PH1
DEFAULT	0	0	0	0	0	0	0	0

BEEP_SEL5

BIT	7	6	5	4	3	2	1	0
NAME	B_FANIN 8	B_FANIN 7	B_FANIN 6	B_FANIN 5	B_FANIN 4	B_FANIN 3	B_FANIN 2	B_FANIN 1
DEFAULT	0	0	0	0	0	0	0	0

BEEP_SEL6

BIT	7	6	5	4	3	2	1	0
NAME	Reserved	Reserved	Reserved	Reserved	B_FANIN 12	B_FANIN 11	B_FANIN 10	B_FANIN 9
DEFAULT	0	0	0	0	0	0	0	0

BEEP_SEL7

BIT	7	6	5	4	3	2	1	0
NAME	Reserved	Reserved	Reserved	Reserved	B_TCPU4	B_TCPU3	B_TCPU2	B_TCPU1
DEFAULT	0	0	0	0	0	0	0	0

BEEP_SEL8

BIT	7	6	5	4	3	2	1	0
NAME	Reserved	Reserved	Reserved	Reserved	B_TCPU8	B_TCPU7	B_TCPU6	B_TCPU5
DEFAULT	0	0	0	0	0	0	0	0

BEEP_SEL9

BIT	7	6	5	4	3	2	1	0
NAME	Reserved	B_CHAS SIS	Reserved	Reserved	B_PCPU4	B_PCPU3	B_PCPU2	B_PCPU1
DEFAULT	0	0	0	0	0	0	0	0

7.1.24 Lock Watch Dog Register

Location: Bank 0 Address E0_{HEX}

Type: Write Only

Reset: Power On Reset

Default Value: 00_{HEX}

BIT	DESCRIPTION
7-0	UNLOCK CODE Write 55 _{HEX} , Enables Soft Watch Dog Timer Write AA _{HEX} , Disables Soft Watch Dog Timer Write 33 _{HEX} , Enables Hard Watch Dog Timer Write CC _{HEX} , Disables Hard Watch Dog Timer

7.1.25 Watch Dog Enable Register

Location: Bank 0 Address E1_{HEX}

Type: Read Only

Reset: Power On Reset

Default Value: 00_{HEX}

BIT	DESCRIPTION
7-2	Reserved.
1	HARD 0 = Hard Watch Dog is disabled 1 = Hard Watch Dog is enabled
0	SOFT 0 = Soft Watch Dog is disabled 1 = Soft Watch Dog is enabled

7.1.26 Watch Dog Status Register

Location: Bank 0 Address E2_{HEX}

Type: Read Only

Reset: Power On Reset

Default Value: 00_{HEX}

BIT	DESCRIPTION
7-4	Reserved
3-2	WDT_ST These 2 bits record last WDT stage for BIOS readout. The information is used to help BIOS to identify WDT timeout issuance
1	HARD_TO 1 = A hard timeout occurs. This bit will be cleared after reading
0	SOFT_TO 1 = A soft timeout occurs. This bit will be cleared after reading

7.1.27 Watch Dog Timer Register

Location: Bank 0 Address E3_{HEX}

Type: Read / Write

Reset: Power On Reset

Default Value: 00_{HEX}

BIT	DESCRIPTION
7-0	WDT TIMER – Timeout timer To write 00 _{HEX} can disable the timer while in Hard Watch Dog Timer mode. To set Timeout Time for SOFT Watch Dog Timer, the unit is minute

7.1.28 GPIO Control Register

Reset: Power On Reset
RESETIN# with LOCK=0

GPIO G0 EN – GPIO Group 0 I/O Enable Control Register

Location: Bank 0 Address E8_{HEX}

Default Value: 60_{HEX}

Type: Read / Write

BIT	DESCRIPTION
7	Reserved
6-0	GPIO G0 EN – Select GPIOG-GPIOA I/O Enable. 0 = GPIOG-A are disable. 1 = GPIOG-A are enable.

GPIO G0 DIR – GPIO Group 0 I/O Direction Control Register

Location: Bank 0 Address E9_{HEX}

Default Value: 7F_{HEX}

Type: Read / Write

BIT	DESCRIPTION
7	Reserved
6-0	GPIO G0 DIR – Select GPIOG-GPIOA I/O Direction. 0 = GPIOG-A are programming as output pins. 1 = GPIOG-A are programming as input pins. (default)

GPIO G0 OUT – GPIO Group 0 Output Data Register

Location: Bank 0 Address EA_{HEX}

Default Value: 00_{HEX}

Type: Read / Write

BIT	DESCRIPTION
7-0	GPIO G0 OUT – Output GPIOG-GPIOA Data. For output ports, it needs to set GPIO_G0_EN register and the respective bits can be read/written and produced to pins.

GPIO G0 IN – GPIO Group 0 Input Data Register

Location: Bank 0 Address EB_{HEX}

Default Value: N.A.

Type: Read Only

BIT	DESCRIPTION
7-0	GPIO G0 IN – Input GPIOG-GPIOA Data. The respective bits can be read only from pins. Write accesses will be ignored.

GPIO G1 EN – GPIO Group 1 I/O Enable Control Register

Location: Bank 0 Address EC_{HEX}

Default Value: 00_{HEX}

Type: Read / Write

BIT	DESCRIPTION
7-4	Reserved
3-0	GPIO G1 EN – Select GPIO16-GPIO13 I/O Enable. 0 = GPIO16-13 are disable. 1 = GPIO16-13 are enable.

GPIO G1 DIR – GPIO Group 1 I/O Direction Control Register

Location: Bank 0 Address ED_{HEX}

Default Value: 0F_{HEX}

Type: Read / Write

BIT	DESCRIPTION
7-4	Reserved
3-0	GPIO G1 DIR – Select GPIO16-GPIO13 I/O Direction. 0 = GPIO16-13 are programming as output pins. 1 = GPIO16-13 are programming as input pins. (default)

GPIO G1 OUT – GPIO Group 1 Output Data Register

Location: Bank 0 Address EE_{HEX}

Default Value: 00_{HEX}

Type: Read / Write

BIT	DESCRIPTION
3-0	GPIO G1 OUT – Output GPIO16-GPIO13 Data. For output ports, it needs to set GPIO_G1_EN register and the respective bits can be read/written and produced to pins.

GPIO G1 IN – GPIO Group 1 Input Data Register

Location: Bank 0 Address EF_{HEX}

Default Value: N.A.

Type: Read Only

BIT	DESCRIPTION
3-0	GPIO G1 IN – Input GPIO16-GPIO13 Data. The respective bits can be read only from pins. Write accesses will be ignored.

7.1.29 PCH DTS Monitored Value Register

- Location: **PCH_MAX** - Bank 0 Address F0_{HEX}
- PCH_PCH** - Bank 0 Address F1_{HEX}
- PCH_CPU_F** - Bank 0 Address F2_{HEX}
- PCH_CPU_I** - Bank 0 Address F3_{HEX}
- PCH_MCH** - Bank 0 Address F4_{HEX}
- PCH_DIMM0** - Bank 0 Address F5_{HEX}
- PCH_DIMM1** - Bank 0 Address F6_{HEX}
- PCH_DIMM2** - Bank 0 Address F7_{HEX}
- PCH_DIMM3** - Bank 0 Address F8_{HEX}
- PCH_SN** - Bank 0 Address F9_{HEX}
- PCH_CPU_EG0** - Bank 0 Address FA_{HEX}
- PCH_CPU_EG1** - Bank 0 Address FB_{HEX}
- PCH_CPU_EG2** - Bank 0 Address FC_{HEX}
- PCH_CPU_EG3** - Bank 0 Address FD_{HEX}

Type: Read Only
 Reset: Power On Reset

According to different Intel ME firmware version, the PCH temperature could be placed in either address F0h or F1h.

PCH_MAX – PCH PCH_0 Temperature Value Register

Location: Bank 0 Address F0_{HEX}
 Default Value: N/A

BIT	DESCRIPTION
7-0	PCH_PCH_0_TEMP[7:0] PCH PCH_0 Temperature Value (It can be one of temperature sources for the FAN controller)

PCH_PCH – PCH PCH_1 Temperature Value Register

Location: Bank 0 Address F1_{HEX}
 Default Value: N/A

BIT	DESCRIPTION
7-0	PCH_PCH_1_TEMP[7:0] PCH PCH_1 Temperature Value (It can be one of temperature sources for the FAN controller)

PCH_CPU_F – PCH CPU Fractional Temperature Value Register

Location: Bank 0 Address F2_{HEX}
 Default Value: N/A

BIT	DESCRIPTION
7-0	PCH_CPU_FRA_TEMP[7:0] PCH CPU Fractional Temperature Value

PCH_CPU_I – PCH CPU Integer Temperature Value Register

Location: Bank 0 Address F3_{HEX}

Default Value: N/A

BIT	DESCRIPTION
7-0	PCH_CPU_INT_TEMP[7:0] PCH CPU Integer Temperature Value (It can be one of temperature sources for the FAN controller)

PCH_MCH – PCH MCH Temperature Value Register

Location: Bank 0 Address F4_{HEX}

Default Value: N/A

BIT	DESCRIPTION
7-0	PCH_MCH_TEMP[7:0] PCH MCH Temperature Value (It can be one of temperature sources for the FAN controller)

PCH_DIMM0 – PCH DIMM0 Temperature Value Register

Location: Bank 0 Address F5_{HEX}

Default Value: N/A

BIT	DESCRIPTION
7-0	PCH_DIMM0_TEMP[7:0] PCH DIMM0 Temperature Value (It can be one of temperature sources for the FAN controller)

PCH_DIMM1 – PCH DIMM1 Temperature Value Register

Location: Bank 0 Address F6_{HEX}

Default Value: N/A

BIT	DESCRIPTION
7-0	PCH_DIMM1_TEMP[7:0] PCH DIMM1 Temperature Value (It can be one of temperature sources for the FAN controller)

PCH_DIMM2 – PCH DIMM2 Temperature Value Register

Location: Bank 0 Address F7_{HEX}

Default Value: N/A

BIT	DESCRIPTION
7-0	PCH_DIMM2_TEMP[7:0] PCH DIMM2 Temperature Value (It can be one of temperature sources for the FAN controller)

PCH_DIMM3 – PCH DIMM3 Temperature Value Register

Location: Bank 0 Address F8_{HEX}

Default Value: N/A

BIT	DESCRIPTION
7-0	PCH_DIMM3_TEMP[7:0] PCH DIMM3 Temperature Value (It can be one of temperature sources for the FAN controller)

PCH_SN – PCH Sequence Number Value Register

Location: Bank 0 Address F9_{HEX}

Default Value: N/A

BIT	DESCRIPTION
7-0	PCH_SEQ_NUM[7:0] PCH Sequence Number Value

PCH_CPU_EG0 – PCH CPU Latest Energy Value Register

Location: Bank 0 Address FA_{HEX}

Default Value: N/A

BIT	DESCRIPTION
7-0	PCH_CPU_ERG[7:0] PCH CPU Latest Energy Value

PCH_CPU_EG1 – PCH CPU Latest Energy Value Register

Location: Bank 0 Address FB_{HEX}

Default Value: N/A

BIT	DESCRIPTION
7-0	PCH_CPU_ERG[15:8] PCH CPU Latest Energy Value

PCH_CPU_EG2 – PCH CPU Latest Energy Value Register

Location: Bank 0 Address FC_{HEX}

Default Value: N/A

BIT	DESCRIPTION
7-0	PCH_CPU_ERG[23:16] PCH CPU Latest Energy Value

PCH_CPU_EG3 – PCH CPU Latest Energy Value Register

Location: Bank 0 Address FD_{HEX}

Default Value: N/A

BIT	DESCRIPTION
7-0	PCH_CPU_ERG[31:24] PCH CPU Latest Energy Value

7.1.30 Bank Select Register

Location: Bank 0, 1, 2, 3 Address FF_{HEX}

Type: Read / Write

Reset: Power On Reset
 RESETIN# with LOCK=0

Default Value: 00_{HEX}

BIT	DESCRIPTION
7-3	Reserved.
2-0	BANK_SEL[2:0] 000 _{BIN} = Bank 0 001 _{BIN} = Bank 1 010 _{BIN} = Bank 2 011 _{BIN} = Bank 3 100 _{BIN} = Bank 4 101 _{BIN} ~ 111 _{BIN} = Reserved

7.2 Bank 1 REGISTER DETAIL

7.2.1 Voltage and Temperature Channel Limitation Register

Location:

VSEN1_HV_HL	- Bank 1 Address 00 _{HEX}
VSEN1_LV_HL	- Bank 1 Address 01 _{HEX}
VSEN1_HV_LL	- Bank 1 Address 02 _{HEX}
VSEN1_LV_LL	- Bank 1 Address 03 _{HEX}
VSEN2_HV_HL / TEMP_CH1_C	- Bank 1 Address 04 _{HEX}
VSEN2_LV_HL / TEMP_CH1_CH	- Bank 1 Address 05 _{HEX}
VSEN2_HV_LL / TEMP_CH1_W	- Bank 1 Address 06 _{HEX}
VSEN2_LV_LL / TEMP_CH1_WH	- Bank 1 Address 07 _{HEX}
VSEN3_HV_HL	- Bank 1 Address 08 _{HEX}
VSEN3_LV_HL	- Bank 1 Address 09 _{HEX}
VSEN3_HV_LL	- Bank 1 Address 0A _{HEX}
VSEN3_LV_LL	- Bank 1 Address 0B _{HEX}
VSEN4_HV_HL / TEMP_CH2_C	- Bank 1 Address 0C _{HEX}
VSEN4_LV_HL / TEMP_CH2_CH	- Bank 1 Address 0D _{HEX}
VSEN4_HV_LL / TEMP_CH2_W	- Bank 1 Address 0E _{HEX}
VSEN4_LV_LL / TEMP_CH2_WH	- Bank 1 Address 0F _{HEX}
VSEN5_HV_HL	- Bank 1 Address 10 _{HEX}
VSEN5_LV_HL	- Bank 1 Address 11 _{HEX}
VSEN5_HV_LL	- Bank 1 Address 12 _{HEX}
VSEN5_LV_LL	- Bank 1 Address 13 _{HEX}
VSEN6_HV_HL / TEMP_CH3_C	- Bank 1 Address 14 _{HEX}
VSEN6_LV_HL / TEMP_CH3_CH	- Bank 1 Address 15 _{HEX}
VSEN6_HV_LL / TEMP_CH3_W	- Bank 1 Address 16 _{HEX}
VSEN6_LV_LL / TEMP_CH3_WH	- Bank 1 Address 17 _{HEX}
VSEN7_HV_HL	- Bank 1 Address 18 _{HEX}
VSEN7_LV_HL	- Bank 1 Address 19 _{HEX}
VSEN7_HV_LL	- Bank 1 Address 1A _{HEX}
VSEN7_LV_LL	- Bank 1 Address 1B _{HEX}
VSEN8_HV_HL / TEMP_CH4_C	- Bank 1 Address 1C _{HEX}
VSEN8_LV_HL / TEMP_CH4_CH	- Bank 1 Address 1D _{HEX}
VSEN8_HV_LL / TEMP_CH4_W	- Bank 1 Address 1E _{HEX}
VSEN8_LV_LL / TEMP_CH4_WH	- Bank 1 Address 1F _{HEX}
VSEN9_HV_HL	- Bank 1 Address 20 _{HEX}
VSEN9_LV_HL	- Bank 1 Address 21 _{HEX}
VSEN9_HV_LL	- Bank 1 Address 22 _{HEX}
VSEN9_LV_LL	- Bank 1 Address 23 _{HEX}
VSEN10_HV_HL	- Bank 1 Address 24 _{HEX}
VSEN10_LV_HL	- Bank 1 Address 25 _{HEX}
VSEN10_HV_LL	- Bank 1 Address 26 _{HEX}
VSEN10_LV_LL	- Bank 1 Address 27 _{HEX}
VSEN11_HV_HL	- Bank 1 Address 28 _{HEX}

VSEN11_LV_HL	- Bank 1 Address 29 _{HEX}
VSEN11_HV_LL	- Bank 1 Address 2A _{HEX}
VSEN11_LV_LL	- Bank 1 Address 2B _{HEX}
VSEN12_HV_HL	- Bank 1 Address 2C _{HEX}
VSEN12_LV_HL	- Bank 1 Address 2D _{HEX}
VSEN12_HV_LL	- Bank 1 Address 2E _{HEX}
VSEN12_LV_LL	- Bank 1 Address 2F _{HEX}
VSEN13_HV_HL	- Bank 1 Address 30 _{HEX}
VSEN13_LV_HL	- Bank 1 Address 31 _{HEX}
VSEN13_HV_LL	- Bank 1 Address 32 _{HEX}
VSEN13_LV_LL	- Bank 1 Address 33 _{HEX}
VSEN14_HV_HL	- Bank 1 Address 34 _{HEX}
VSEN14_LV_HL	- Bank 1 Address 35 _{HEX}
VSEN14_HV_LL	- Bank 1 Address 36 _{HEX}
VSEN14_LV_LL	- Bank 1 Address 37 _{HEX}
3VDD_HV_HL	- Bank 1 Address 38 _{HEX}
3VDD_LV_HL	- Bank 1 Address 39 _{HEX}
3VDD_HV_LL	- Bank 1 Address 3A _{HEX}
3VDD_LV_LL	- Bank 1 Address 3B _{HEX}
VBAT_HV_HL	- Bank 1 Address 3C _{HEX}
VBAT_LV_HL	- Bank 1 Address 3D _{HEX}
VBAT_HV_LL	- Bank 1 Address 3E _{HEX}
VBAT_LV_LL	- Bank 1 Address 3F _{HEX}
V3VSB_HV_HL	- Bank 1 Address 40 _{HEX}
V3VSB_LV_HL	- Bank 1 Address 41 _{HEX}
V3VSB_HV_LL	- Bank 1 Address 42 _{HEX}
V3VSB_LV_LL	- Bank 1 Address 43 _{HEX}
LTD_HV_HL	- Bank 1 Address 44 _{HEX}
LTD_LV_HL	- Bank 1 Address 45 _{HEX}
LTD_HV_LL	- Bank 1 Address 46 _{HEX}
LTD_LV_LL	- Bank 1 Address 47 _{HEX}
VSEN17_HV_HL	- Bank 1 Address 80 _{HEX}
VSEN17_LV_HL	- Bank 1 Address 81 _{HEX}
VSEN17_HV_LL	- Bank 1 Address 82 _{HEX}
VSEN17_LV_LL	- Bank 1 Address 83 _{HEX}
VSEN18_HV_HL	- Bank 1 Address 84 _{HEX}
VSEN18_LV_HL	- Bank 1 Address 85 _{HEX}
VSEN18_HV_LL	- Bank 1 Address 86 _{HEX}
VSEN18_LV_LL	- Bank 1 Address 87 _{HEX}
VSEN19_HV_HL	- Bank 1 Address 88 _{HEX}
VSEN19_LV_HL	- Bank 1 Address 89 _{HEX}
VSEN19_HV_LL	- Bank 1 Address 8A _{HEX}
VSEN19_LV_LL	- Bank 1 Address 8B _{HEX}

Type: Read / Write
 Reset: Power On Reset
 RESETIN# with LOCK=0

HIGH VALUE HIGH LIMITATION

Default Value: FF_{HEX}

BIT	7	6	5	4	3	2	1	0
NAME	High Value High Limitation 11-bit voltage value bit[10:2]							

LOW VALUE HIGH LIMITATION

Default Value: 07_{HEX}

BIT	7	6	5	4	3	2	1	0
NAME	Reserved					High Value High Limitation 11-bit voltage value bit[2:0]		

HIGH VALUE LOW LIMITATION

Default Value: 00_{HEX}

BIT	7	6	5	4	3	2	1	0
NAME	High Value Low Limitation 11-bit voltage value bit[10:2]							

LOW VALUE LOW LIMITATION

Default Value: 00_{HEX}

BIT	7	6	5	4	3	2	1	0
NAME	Reserved					High Value Low Limitation 11-bit voltage value bit[2:0]		

CRITICAL TEMPERATURE

Default Value: FF_{HEX}

BIT	7	6	5	4	3	2	1	0
NAME	Critical Temperature The format of Temperature is 8-bit 2's complement and the range is -128°C~127°C.							

CRITICAL TEMPERATURE HYSTERESIS

Default Value: 07_{HEX}

BIT	7	6	5	4	3	2	1	0
NAME	Critical Temperature Hysteresis The format of Temperature is 8-bit 2's complement and the range is -128°C~127°C.							

WARNING TEMPERATURE

Default Value: 00_{HEX}

BIT	7	6	5	4	3	2	1	0
NAME	Warning Temperature The format of Temperature is 8-bit 2's complement and the range is -128°C~127°C.							

WARNING TEMPERATURE HYSTERESIS

Default Value: 00_{HEX}

BIT	7	6	5	4	3	2	1	0
NAME	Warning Temperature Hysteresis The format of Temperature is 8-bit 2's complement and the range is -128°C~127°C.							

7.2.2 PROCHOT Limitation Register

Location: Bank 1 Address 50_{HEX}

Type: Read / Write

Reset: Power On Reset
 RESETIN# with LOCK=0

Default Value: FF_{HEX}

BIT	DESCRIPTION
7-0	P1_PROCHOT#_NV_HL[7:0] CPU1 PROCHOT# Numerator High Limitation

7.2.3 FAN Input Channel Limitation Register

- Location:
- FANIN1_HV_HL** - Bank 1 Address 60_{HEX}
 - FANIN1_LV_HL** - Bank 1 Address 61_{HEX}
 - FANIN2_HV_HL** - Bank 1 Address 62_{HEX}
 - FANIN2_LV_HL** - Bank 1 Address 63_{HEX}
 - FANIN3_HV_HL** - Bank 1 Address 64_{HEX}
 - FANIN3_LV_HL** - Bank 1 Address 65_{HEX}
 - FANIN4_HV_HL** - Bank 1 Address 66_{HEX}
 - FANIN4_LV_HL** - Bank 1 Address 67_{HEX}
 - FANIN5_HV_HL** - Bank 1 Address 68_{HEX}
 - FANIN5_LV_HL** - Bank 1 Address 69_{HEX}
 - FANIN6_HV_HL** - Bank 1 Address 6A_{HEX}
 - FANIN6_LV_HL** - Bank 1 Address 6B_{HEX}
 - FANIN7_HV_HL** - Bank 1 Address 6C_{HEX}
 - FANIN7_LV_HL** - Bank 1 Address 6D_{HEX}
 - FANIN8_HV_HL** - Bank 1 Address 6E_{HEX}
 - FANIN8_LV_HL** - Bank 1 Address 6F_{HEX}
 - FANIN9_HV_HL** - Bank 1 Address 70_{HEX}
 - FANIN9_LV_HL** - Bank 1 Address 71_{HEX}
 - FANIN10_HV_HL** - Bank 1 Address 72_{HEX}
 - FANIN10_LV_HL** - Bank 1 Address 73_{HEX}
 - FANIN11_HV_HL** - Bank 1 Address 74_{HEX}
 - FANIN11_LV_HL** - Bank 1 Address 75_{HEX}
 - FANIN12_HV_HL** - Bank 1 Address 76_{HEX}
 - FANIN12_LV_HL** - Bank 1 Address 77_{HEX}

Type: Read / Write

Reset: Power On Reset
 RESETIN# with LOCK=0

FANIN HIGH VALUE HIGH LIMITATION

BIT	7	6	5	4	3	2	1	0
NAME	Fan Input Count High Value High Limitation 13-bit voltage value bit[12:5]							

FANIN LOW VALUE HIGH LIMITATION

BIT	7	6	5	4	3	2	1	0
NAME	Reserved			Fan Input Count Low Value High Limitation 13-bit voltage value bit[4:0]				

7.2.4 DTS Temperature Power Limitation Registers

Location:

- DTS_T_CPU1_C - Bank 1 Address 90_{HEX}
- DTS_T_CPU1_CH - Bank 1 Address 91_{HEX}
- DTS_T_CPU1_W - Bank 1 Address 92_{HEX}
- DTS_T_CPU1_WH - Bank 1 Address 93_{HEX}
- DTS_T_CPU2_C - Bank 1 Address 94_{HEX}
- DTS_T_CPU2_CH - Bank 1 Address 95_{HEX}
- DTS_T_CPU2_W - Bank 1 Address 96_{HEX}
- DTS_T_CPU2_WH - Bank 1 Address 97_{HEX}
- DTS_T_CPU3_C - Bank 1 Address 98_{HEX}
- DTS_T_CPU3_CH - Bank 1 Address 99_{HEX}
- DTS_T_CPU3_W - Bank 1 Address 9A_{HEX}
- DTS_T_CPU3_WH - Bank 1 Address 9B_{HEX}
- DTS_T_CPU4_C - Bank 1 Address 9C_{HEX}
- DTS_T_CPU4_CH - Bank 1 Address 9D_{HEX}
- DTS_T_CPU4_W - Bank 1 Address 9E_{HEX}
- DTS_T_CPU4_WH - Bank 1 Address 9F_{HEX}
- DTS_T_CPU5_C - Bank 1 Address A0_{HEX}
- DTS_T_CPU5_CH - Bank 1 Address A1_{HEX}
- DTS_T_CPU5_W - Bank 1 Address A2_{HEX}
- DTS_T_CPU5_WH - Bank 1 Address A3_{HEX}
- DTS_T_CPU6_C - Bank 1 Address A4_{HEX}
- DTS_T_CPU6_CH - Bank 1 Address A5_{HEX}
- DTS_T_CPU6_W - Bank 1 Address A6_{HEX}
- DTS_T_CPU6_WH - Bank 1 Address A7_{HEX}
- DTS_T_CPU7_C - Bank 1 Address A8_{HEX}
- DTS_T_CPU7_CH - Bank 1 Address A9_{HEX}
- DTS_T_CPU7_W - Bank 1 Address AA_{HEX}
- DTS_T_CPU7_WH - Bank 1 Address AB_{HEX}
- DTS_T_CPU8_C - Bank 1 Address AC_{HEX}
- DTS_T_CPU8_CH - Bank 1 Address AD_{EX}
- DTS_T_CPU8_W - Bank 1 Address AE_{HEX}
- DTS_T_CPU8_WH - Bank 1 Address AF_{HEX}
- DTS_P_CPU1_C - Bank 1 Address B0_{HEX}

- DTS_P_CPU1_CH - Bank 1 Address B1_{HEX}
- DTS_P_CPU1_W - Bank 1 Address B2_{HEX}
- DTS_P_CPU1_WH - Bank 1 Address B3_{HEX}
- DTS_P_CPU2_C - Bank 1 Address B4_{HEX}
- DTS_P_CPU2_CH - Bank 1 Address B5_{HEX}
- DTS_P_CPU2_W - Bank 1 Address B6_{HEX}
- DTS_P_CPU2_WH - Bank 1 Address B7_{HEX}
- DTS_P_CPU3_C - Bank 1 Address B8_{HEX}
- DTS_P_CPU3_CH - Bank 1 Address B9_{HEX}
- DTS_P_CPU3_W - Bank 1 Address BA_{HEX}
- DTS_P_CPU3_WH - Bank 1 Address BB_{HEX}
- DTS_P_CPU4_C - Bank 1 Address BC_{HEX}
- DTS_P_CPU4_CH - Bank 1 Address BD_{HEX}
- DTS_P_CPU4_W - Bank 1 Address BE_{EX}
- DTS_P_CPU4_WH - Bank 1 Address BF_{HEX}

Reset: Power On Reset
 RESETIN# with LOCK=0

CRITICAL TEMPERATURE

BIT	7	6	5	4	3	2	1	0
NAME	Critical Temperature The format of Temperature is 8-bit 2's complement and the range is -128°C~127°C.							
VALUE	SIGN	64	32	16	8	4	2	1
DEFAULT	64 _{HEX} (100°C)							

CRITICAL TEMPERATURE HYSTERESIS

BIT	7	6	5	4	3	2	1	0
NAME	Critical Temperature Hysteresis The format of Temperature is 8-bit 2's complement and the range is -128°C~127°C.							
VALUE	SIGN	64	32	16	8	4	2	1
DEFAULT	5F _{HEX} (95°C)							

WARNING TEMPERATURE

BIT	7	6	5	4	3	2	1	0
NAME	Warning Temperature The format of Temperature is 8-bit 2's complement and the range is -128°C~127°C.							
VALUE	SIGN	64	32	16	8	4	2	1
DEFAULT	55 _{HEX} (85 °C)							

WARNING TEMPERATURE HYSTERESIS

BIT	7	6	5	4	3	2	1	0
NAME	Warning Temperature Hysteresis The format of Temperature is 8-bit 2's complement and the range is -128°C~127°C.							

VALUE	SIGN	64	32	16	8	4	2	1
DEFAULT	50 _{HEX} (80 °C)							

7.2.5 PROCHOT Control Registers

Location: Bank 1 Address D0_{HEX}

Type: Read / Write

Reset: Power On Reset
 RESETIN# with LOCK=0

Default Value: 4F_{HEX}

BIT	DESCRIPTION
7	Reserved
6	PH1_MD – Set the PROCHOT1# mode. 0 = Output mode 1 = Input mode (default)
5-4	PH1_FSEL – Set the PROCHOT1# sample period time. 00 = 22us (default) 01 = 44us 10 = 88us 11 = 176us
3-0	PH1_DC – Set the PROCHOT1# output duty cycle. 0000 = 1 sample time low 0001 = 2 sample times low 0010 = 3 sample times low 0011 = 4 sample times low 0100 = 5 sample times low 0101 = 6 sample times low 0110 = 7 sample times low 0111 = 8 sample times low 1000 = 9 sample times low 1001 = 10 sample times low 1010 = 11 sample times low 1011 = 12 sample times low 1100 = 13 sample times low 1101 = 14 sample times low 1110 = 15 sample times low 1111 = all low (default)

7.2.6 PROCHOT Source Selection Registers

Location:

- PH1_VT_ADC** - Bank 1 Address D1_{HEX}
- PH1_DTS_T0** - Bank 1 Address D2_{HEX}
- PH1_DTS_T1** - Bank 1 Address D3_{HEX}
- PH1_DTS_P** - Bank 1 Address D4_{HEX}

Type: Read / Write

Reset: Power On Reset
RESETIN# with LOCK=0

PH1_VT_ADC – P1_PROCHOT Temperature Select Register

Location: Bank 1 Address D1_{HEX}

Default Value: 20_{HEX}

BIT	DESCRIPTION
7-5	Reserved
4	PH1_LTD – Enable P1_PROCHOT# for LTD 0 = Disable 1 = Enable
3	PH1_VSEN89 – Enable P1_PROCHOT# for VSEN89 0 = Disable 1 = Enable
2	PH1_VSEN67 – Enable P1_PROCHOT# for VSEN67 0 = Disable 1 = Enable
1	PH1_VSEN45 – Enable P1_PROCHOT# for VSEN45 0 = Disable 1 = Enable
0	PH1_VSEN23 – Enable P1_PROCHOT# for VSEN23 0 = Disable 1 = Enable

PH1_DTS_T0 – P1_PROCHOT DTS Temperature 0 Select Register

Location: Bank 1 Address D2_{HEX}

Default Value: 00_{HEX}

BIT	DESCRIPTION
7-4	Reserved
3	PH1_TCPU4 – Enable P1_PROCHOT# for TCPU4 0 = Disable 1 = Enable
2	PH1_TCPU3 – Enable P1_PROCHOT# for TCPU3 0 = Disable 1 = Enable
1	PH1_TCPU2 – Enable P1_PROCHOT# for TCPU2 0 = Disable 1 = Enable

BIT	DESCRIPTION
0	PH1_TCPU1 – Enable P1_PROCHOT# for TCPU1 0 = Disable 1 = Enable

PH1_DTS_T1 – P1_PROCHOT DTS Temperature 1 Select Register

Location: Bank 1 Address D3_{HEX}

Default Value: 00_{HEX}

BIT	DESCRIPTION
7-4	Reserved
3	PH1_TCPU8 – Enable P1_PROCHOT# for TCPU8 0 = Disable 1 = Enable
2	PH1_TCPU7 – Enable P1_PROCHOT# for TCPU7 0 = Disable 1 = Enable
1	PH1_TCPU6 – Enable P1_PROCHOT# for TCPU6 0 = Disable 1 = Enable
0	PH1_TCPU5 – Enable P1_PROCHOT# for TCPU5 0 = Disable 1 = Enable

PH1_DTS_P – P1_PROCHOT DTS Power Select Register

Location: Bank 1 Address D4_{HEX}

Default Value: 00_{HEX}

BIT	DESCRIPTION
7-4	Reserved
3	PH1_PCPU4 – Enable P1_PROCHOT# for PCPU4 0 = Disable 1 = Enable
2	PH1_PCPU3 – Enable P1_PROCHOT# for PCPU3 0 = Disable 1 = Enable
1	PH1_PCPU2 – Enable P1_PROCHOT# for PCPU2 0 = Disable 1 = Enable
0	PH1_PCPU1 – Enable P1_PROCHOT# for PCPU1 0 = Disable 1 = Enable

7.2.7 Voltage Fault Control Registers

Location: Bank 1 Address D8_{HEX}

Type: Read / Write

Reset: Power On Reset
RESETIN# with LOCK=0

Default Value: 00_{HEX}

BIT	DESCRIPTION
7	EN_VFAULT – Enable voltage fault function. 0 = Disable 1 = Enable
6-0	Reserved

7.2.8 Voltage Fault Source Selection Registers

Location:

VF_SEL0 - Bank 1 Address D9_{HEX}

VF_SEL1 - Bank 1 Address DA_{HEX}

VF_SEL2 - Bank 1 Address DB_{HEX}

Type: Read / Write

Reset: Power On Reset
RESETIN# with LOCK=0

VF_SEL0 – Voltage Fault Select Register

Location: Bank 1 Address D9_{HEX}

Default Value: 00_{HEX}

BIT	DESCRIPTION
7	VF_VSEN8 – Enable VOLT_ALM# for VSEN8 0 = Disable 1 = Enable
6	VF_VSEN7 – Enable VOLT_ALM# for VSEN7 0 = Disable 1 = Enable
5	VF_VSEN6 – Enable VOLT_ALM# for VSEN6 0 = Disable 1 = Enable
4	VF_VSEN5 – Enable VOLT_ALM# for VSEN5 0 = Disable 1 = Enable
3	VF_VSEN4 – Enable VOLT_ALM# for VSEN4 0 = Disable 1 = Enable
2	VF_VSEN3 – Enable VOLT_ALM# for VSEN3 0 = Disable 1 = Enable

BIT	DESCRIPTION
1	VF_VSEN2 – Enable VOLT_ALM# for VSEN2 0 = Disable 1 = Enable
0	VF_VSEN1 – Enable VOLT_ALM# for VSEN1 0 = Disable 1 = Enable

VF_SEL1 – Voltage Fault Select Register

Location: Bank 1 Address DA_{HEX}

Default Value: 00_{HEX}

BIT	DESCRIPTION
7	VF_VBAT – Enable VOLT_ALM# for VBAT 0 = Disable 1 = Enable
6	VF_3VDD – Enable VOLT_ALM# for 3VDD 0 = Disable 1 = Enable
5	VF_VSEN14 – Enable VOLT_ALM# for VSEN14 0 = Disable 1 = Enable
4	VF_VSEN13 – Enable VOLT_ALM# for VSEN13 0 = Disable 1 = Enable
3	VF_VSEN12 – Enable VOLT_ALM# for VSEN12 0 = Disable 1 = Enable
2	VF_VSEN11 – Enable VOLT_ALM# for VSEN11 0 = Disable 1 = Enable
1	VF_VSEN10 – Enable VOLT_ALM# for VSEN10 0 = Disable 1 = Enable
0	VF_VSEN9 – Enable VOLT_ALM# for VSEN9 0 = Disable 1 = Enable

VF_SEL2 – Voltage Fault Select Register

Location: Bank 1 Address DB_{HEX}

Default Value: 00_{HEX}

BIT	DESCRIPTION
7-5	Reserved
4	VF_VSEN19 – Enable VOLT_ALM# for VSEN19 0 = Disable 1 = Enable
3	VF_VSEN18 – Enable VOLT_ALM# for VSEN18

BIT	DESCRIPTION
	0 = Disable 1 = Enable
2	VF_VSEN17 – Enable VOLT_ALM# for VSEN17 0 = Disable 1 = Enable
1	Reserved
0	VF_V3VSB – Enable VOLT_ALM# for 3VSB 0 = Disable 1 = Enable

7.2.9 Fan Fault Control Registers

Location: Bank 1 Address DC_{HEX}

Type: Read / Write

Reset: Power On Reset

Default Value: 00_{HEX}

BIT	DESCRIPTION
7	EN_FFAULT – Enable fan fault function. 0 = Disable 1 = Enable
6-0	Reserved

7.2.10 Fan Fault Source Selection Registers

Location:

FF_SEL0 - Bank 1 Address DD_{HEX}

FF_SEL1 - Bank 1 Address DE_{HEX}

Type: Read / Write

Reset: Power On Reset

RESETIN# with LOCK=0

FF_SEL0 – Fan Fault Select Register

Location: Bank 1 Address DD_{HEX}

Default Value: 00_{HEX}

BIT	DESCRIPTION
7	FF_FANIN8 – Enable FAN_ALM# for FANIN8 0 = Disable 1 = Enable
6	FF_FANIN7 – Enable FAN_ALM# for FANIN7 0 = Disable 1 = Enable
5	FF_FANIN6 – Enable FAN_ALM# for FANIN6 0 = Disable 1 = Enable
4	FF_FANIN5 – Enable FAN_ALM# for FANIN5

BIT	DESCRIPTION
	0 = Disable 1 = Enable
3	FF_FANIN4 – Enable FAN_ALM# for FANIN4 0 = Disable 1 = Enable
2	FF_FANIN3 – Enable FAN_ALM# for FANIN3 0 = Disable 1 = Enable
1	FF_FANIN2 – Enable FAN_ALM# for FANIN2 0 = Disable 1 = Enable
0	FF_FANIN1 – Enable FAN_ALM# for FANIN1 0 = Disable 1 = Enable

FF_SEL1 – Fan Fault Select Register

Location: Bank 1 Address DE_{HEX}

Default Value: 00_{HEX}

BIT	DESCRIPTION
7-4	Reserved
3	FF_FANIN12 – Enable FAN_ALM# for FANIN12 0 = Disable 1 = Enable
2	FF_FANIN11 – Enable FAN_ALM# for FANIN11 0 = Disable 1 = Enable
1	FF_FANIN10 – Enable FAN_ALM# for FANIN10 0 = Disable 1 = Enable
0	FF_FANIN9 – Enable FAN_ALM# for FANIN9 0 = Disable 1 = Enable

7.2.11 Temperature Fault Control Registers

Location: Bank 1 Address E0_{HEX}

Type: Read / Write

Reset: Power On Reset
RESETIN# with LOCK=0

Default Value: 00_{HEX}

BIT	DESCRIPTION
7	EN_TFAULT – Enable temperature fault function. 0 = Disable (Default) 1 = Enable
6	TF_WNC 0 = Temperature fault boundary is critical level (Default) 1 = Temperature fault boundary is warning level
5-0	Reserved.

7.2.12 Temperature Fault Source Selection Registers

Location:

TF_SEL0 - Bank 1 Address E1_{HEX}

TF_SEL1 - Bank 1 Address E2_{HEX}

TF_SEL2 - Bank 1 Address E3_{HEX}

Type: Read / Write

Reset: Power On Reset
RESETIN# with LOCK=0

TF_SEL0 – Temperature Fault Select Register

Location: Bank 1 Address E1_{HEX}

Default Value: 00_{HEX}

BIT	DESCRIPTION
7-5	Reserved
4	TF_LTD – Enable TEMP_ALM# for LTD 0 = Disable 1 = Enable
3	TF_VSEN89 – Enable TEMP_ALM# for VSEN89 0 = Disable 1 = Enable
2	TF_VSEN67 – Enable TEMP_ALM# for VSEN67 0 = Disable 1 = Enable
1	TF_VSEN45 – Enable TEMP_ALM# for VSEN45 0 = Disable 1 = Enable
0	TF_VSEN23 – Enable TEMP_ALM# for VSEN23 0 = Disable

BIT	DESCRIPTION
	1 = Enable

TF_SEL1 – Temperature Fault Select Register

Location: Bank 1 Address E2_{HEX}

Default Value: 00_{HEX}

BIT	DESCRIPTION
7-4	Reserved
3	TF_TCPU4 – Enable TEMP_ALM# for TCPU4 0 = Disable 1 = Enable
2	TF_TCPU3 – Enable TEMP_ALM# for TCPU3 0 = Disable 1 = Enable
1	TF_TCPU2 – Enable TEMP_ALM# for TCPU2 0 = Disable 1 = Enable
0	TF_TCPU1 – Enable TEMP_ALM# for TCPU1 0 = Disable 1 = Enable

TF_SEL2 – Temperature Fault Select Register

Location: Bank 1 Address E3_{HEX}

Default Value: 00_{HEX}

BIT	DESCRIPTION
7-4	Reserved
3	TF_TCPU8 – Enable TEMP_ALM# for TCPU8 0 = Disable 1 = Enable
2	TF_TCPU7 – Enable TEMP_ALM# for TCPU7 0 = Disable 1 = Enable
1	TF_TCPU6 – Enable TEMP_ALM# for TCPU6 0 = Disable 1 = Enable
0	TF_TCPU5 – Enable TEMP_ALM# for TCPU5 0 = Disable 1 = Enable

7.2.13 THERMTRIP Control and Status Register

Location: Bank 1 Address E8_{HEX}

Default Value: 00_{HEX}

Type: Read / Write

Reset: Power On Reset
RESETIN# with LOCK=0

BIT	DESCRIPTION
7-3	Reserved.
2	CLR_THRM – Clear the thermal trip status. If write 1, to clear thermal trip status.
1	EN_THRM – Enable thermal trip event. 0 = Disable 1 = Enable
0	THRM_STS – Thermal trip event status. (Read Only) (Power by VBAT) 0 = Thermal trip event not occurred or be cleared. 1 = Thermal trip event occurred. (It will always be shown no matter what EN_THRM is)

7.3 Bank 2 REGISTER DETAIL

7.3.1 PECEI Function Enable Register (PFE)

Location:

PFE - Bank 2 Address 00_{HEX}

Type: Read / Write

Reset: Power On Reset

RESETIN# with LOCK=0

PFE

BIT	7	6	5	4	3	2	1	0
NAME	PECEI_En	Reserved			Manual_En	BiasRTH_En	GetPower_En	
DEFAULT	18 _{HEX}							

BIT	DESCRIPTION
7	Enable PECEI Host Function. (PECEI_En)
6-3	Reserved
2	Enable PECEI Manual Mode Transaction (Manual_En) Fill in command content into PMMC and PMMWD registers defined in 7.3.8 and 7.3.9 section before enable this bit.
1	Enable function of weighting “Count” retrieved from GetTemp() to form CPU temperature 0 _{BIN} => Disable (It means that Temperature = “Count”) 1 _{BIN} => Enable (It means that Temperature = “Count” * Scale , Scale is defined by Scale_Sel[2:0] in Bank2 Index03)
0	Get Power Function (GetPower_En) This function can routinely return the total energy consumed by the processor. 0 _{BIN} = Disable get CPU Power Function. 1 _{BIN} = Enable get CPU Power Function.

7.3.2 PECEI Timing Configure Register (PTC)

Location:

PTC - Bank 2 Address 01_{HEX}

Type: Read / Write

Reset: Power On Reset

RESETIN# with LOCK=0

PTC

BIT	7	6	5	4	3	2	1	0
NAME	RtHigher	Clamp	ATR		Reserved			
DEFAULT	01 _{HEX}							

BIT	DESCRIPTION
-----	-------------

BIT	DESCRIPTION																				
7	Return Higher Temperature between Doamin0 and domain1. (RtHigher) 0 _{BIN} = The temperature of each agent is returned from domain 0 or domain 1. It depends on control register Bit[3:0] in Bank 2 Address 03 _{HEX} . 1 _{BIN} = Return the higher temperature between domain 0 and domain 1																				
6	PECI clamping function to filter the unreasonable DTS "count" value. (Clamp) 0 = DTS values are fully transparent. 1 = DTS values are clamped in -128 ~ 0.																				
5-4	Adjust Transaction Tbit Rate. (ATR) <table border="1" style="margin-left: 20px;"> <thead> <tr> <th>CLKIN</th> <th>14.318MHz</th> <th>33MHz</th> <th>48MHz</th> </tr> </thead> <tbody> <tr> <td>00_{BIN}</td> <td>Tbit = 1.1us</td> <td>Tbit = 0.5us</td> <td>Tbit = 0.5us</td> </tr> <tr> <td>01_{BIN}</td> <td>Tbit = 2.2us</td> <td>Tbit = 1us</td> <td>Tbit = 1us</td> </tr> <tr> <td>10_{BIN}</td> <td>Tbit = 4.5us</td> <td>Tbit = 2us</td> <td>Tbit = 2us</td> </tr> <tr> <td>11_{BIN}</td> <td>Tbit = 8.9us</td> <td>Tbit = 4us</td> <td>Tbit = 4us</td> </tr> </tbody> </table>	CLKIN	14.318MHz	33MHz	48MHz	00 _{BIN}	Tbit = 1.1us	Tbit = 0.5us	Tbit = 0.5us	01 _{BIN}	Tbit = 2.2us	Tbit = 1us	Tbit = 1us	10 _{BIN}	Tbit = 4.5us	Tbit = 2us	Tbit = 2us	11 _{BIN}	Tbit = 8.9us	Tbit = 4us	Tbit = 4us
CLKIN	14.318MHz	33MHz	48MHz																		
00 _{BIN}	Tbit = 1.1us	Tbit = 0.5us	Tbit = 0.5us																		
01 _{BIN}	Tbit = 2.2us	Tbit = 1us	Tbit = 1us																		
10 _{BIN}	Tbit = 4.5us	Tbit = 2us	Tbit = 2us																		
11 _{BIN}	Tbit = 8.9us	Tbit = 4us	Tbit = 4us																		
3-0	Reserved																				

7.3.3 PECI Agent and Domain Configure Register (PADC)

Location:

PADC - Bank 2 Address 02_{HEX}

Type: Read / Write

Reset: Power On Reset
 RESETIN# with LOCK=0

PADC

BIT	7	6	5	4	3	2	1	0
NAME	En_Agt[3:0]				Dmn1_Agt[3:0]			
DEFAULT	00 _{HEX}							

BIT	DESCRIPTION
7-4	Assign which agent will be approached by PECI host [Bit7] = CPU agent 3 [Bit6] = CPU agent 2 [Bit5] = CPU agent 1 [Bit4] = CPU agent 0
3-0	Indicate which agent equips with domain1. [Bit3] = Agent 3 with / without Domain1 [Bit2] = Agent 2 with / without Domain1 [Bit1] = Agent 1 with / without Domain1 [Bit0] = Agent 0 with / without Domain1

7.3.4 PECEI Relative Temperature Scale Register (PRTS)

Location:

PRTS - Bank 2 Address 03_{HEX}

Type: Read / Write

Reset: Power On Reset

RESETIN# with LOCK=0

PRTS

BIT	7	6	5	4	3	2	1	0
NAME	Reserved	Scale_Sel[2:0]			RtDmn_Agt[3:0]			
DEFAULT	40 _{HEX}							

BIT	DESCRIPTION
7	Reserved
6-4	Weighting “count” to form temperature. It is available only while BIASRTH (Bank 2 Address 00 _{HEX} Bit[1]=1) is asserted, Through this, the final Temperature = “count” * Scale_Sel[2:0]. 000 _{BIN} = 0.78125 001 _{BIN} = 0.84375 010 _{BIN} = 0.90625 011 _{BIN} = 0.96875 100 _{BIN} = 1.03125 101 _{BIN} = 1.09375 110 _{BIN} = 1.15625 111 _{BIN} = 1.21875
3-0	Agent 3 – Agent 0 always return relative temperature in ARTR registers defined by 7.3.11. These bits specify that these relative temperatures are come from domain 0 or domain1. However this configuration is available only while RtHigher (Bank 2 Address 01 _{HEX} Bit[7]) is de-asserted. [bit3] = 0 / 1 => Agent3 will return the relative temperature from domain 0 / domain 1. [bit2] = 0 / 1 => Agent2 will return the relative temperature from domain 0 / domain 1. [bit1] = 0 / 1 => Agent1 will return the relative temperature from domain 0 / domain 1. [bit0] = 0 / 1 => Agent0 will return the relative temperature from domain 0 / domain 1.

7.3.5 DTS Power Source Control Register

Location: Bank 2 Address 04_{HEX}

Default Value: 01_{HEX}

Type: Read / Write

Reset: Power On Reset
RESETIN# with LOCK=0

DPSC

BIT	7	6	5	4	3	2	1	0
NAME	Reserved					DTS_SRC_SEL		T_RTA_EN
DEFAULT	01 _{HEX}							

BIT	DESCRIPTION
7-3	Reserved.
2-1	DTS_SRC_SEL – DTS Source Selection 00 = All from PECL 01 = All from Host (LSN_EN must be disable) 10 = Reserved 11 = Temperature from PECL and Power from Host (LSN_EN must be enable)
0	T_RTA_EN – PECL Temperature Running Time Average Enable 0 = Disable 1 = Enable (Default)

7.3.6 TBit Width Register (TBW)

Location: Bank 2 Address 05_{HEX}

Type: Read

Reset: Power On Reset
RESETIN# with LOCK=0

TBW

BIT	7	6	5	4	3	2	1	0
NAME	LSN_RST_CNT[6:0]							
DEFAULT	00 _{HEX}							

BIT	DESCRIPTION
7-0	Record TBit time in PECL Listening mode. The allowable lowest PECL transaction speed is 125Kz.

7.3.7 PECl Listening Mode Configuration Register (PLMC)

Location: Bank 2 Address 06_{HEX}

Type: Read / Write

Reset: Power On Reset
RESETIN# with LOCK=0

TBW

BIT	7	6	5	4	3	2	1	0
NAME	Reserved			LSN_CMD_ERR	Reserved	LSN_EN	LSN_TBIT_LW[1:0]	
DEFAULT	01 _{HEX}							

BIT	DESCRIPTION
7-5	Reserved
4	LSN_CMD_ERR: Indicator for command error while PECl listening mode is active
3	Reserved
2	LSN_EN: Enable PECl listening mode
1-0	LSN_TBIT_LW: Idle state period selection 00b = 2-TBit 01b = 3-TBit 10b = 4-TBit 11b = 5-TBit

7.3.8 PECl VTT Power Detect Configuration Register (PVCR)

Location: Bank 2 Address 07_{HEX}

Type: Read / Write

Reset: Power On Reset
RESETIN# with LOCK=0

TBW

BIT	7	6	5	4	3	2	1	0
NAME	VTT_OK	Reserved			VTT_CRC	VTT_CLR	VTT_INIT_STS	
DEFAULT	03 _{HEX}							

BIT	DESCRIPTION
7	VTT_OK : VTT power OK indicator. (read only) '0' : VTT is not OK. '1' : VTT is OK.
6-3	Reserved
2	VTT_CRC : CRC input source selection '0' : The input source of CRC is purely from PECl physical bus '1' : The input source of CRC comes from host's internal write-out data and PECl physical bus
1	VTT_CLR : Retention control for absolute temperature data

BIT	DESCRIPTION
	'0' : Keep last data while VTT is loss '1' : Clear absolute temperature data to default value while VTT is loss
0	VTT_INIT_STS : PECl transaction control while VTT is shut off '0' : PECl transaction never stop even though VTT is loss '1' : Suspend PECl transaction while VTT is power loss

7.3.9 PECl Agent Tbase Temperature Register (PATB)

Location:

PATB 0 - Bank 2 Address 08_{HEX}

PATB 1 - Bank 2 Address 09_{HEX}

PATB 2 - Bank 2 Address 0A_{HEX}

PATB 3 - Bank 2 Address 0B_{HEX}

Type: Read / Write

Reset: Power On Reset

RESETIN# with LOCK=0

PATB0

BIT	7	6	5	4	3	2	1	0
NAME	Reserved	Tbase0[6:0]						
DEFAULT	00 _{HEX}							

PATB1

BIT	7	6	5	4	3	2	1	0
NAME	Reserved	Tbase1[6:0]						
DEFAULT	00 _{HEX}							

PATB2

BIT	7	6	5	4	3	2	1	0
NAME	Reserved	Tbase2[6:0]						
DEFAULT	00 _{HEX}							

PATB3

BIT	7	6	5	4	3	2	1	0
NAME	Reserved	Tbase3[6:0]						
DEFAULT	00 _{HEX}							

BIT	DESCRIPTION
7	Reserved
6-0	Agent0 ~ Agent3 Tbase Temperature setting. With these setting, the PECl negative temperature format could be translated into positive format.

7.3.10 PECE Power Averaging Configure Register (PPAC)

Location:

Address - Bank 2 Address 0C_{HEX}

Type: Read / Write

Reset: Power On Reset
RESETIN# with LOCK=0

PPAC

BIT	7	6	5	4	3	2	1	0
NAME	RST_PECI	DTS_En	IvyBridge_En	GetDRAM_En	Reserved		P_AVG_SE L[1:0]	
DEFAULT	0F _{HEX}							

BIT	DESCRIPTION
7	Reset PECE Function
6	Enabling DTS (Sensor) Based Thermal Spec supporting; in addition to PECE transaction, it also affects fan speed control. 1: Enable supporting DTS based thermal spec 0: Disable supporting
5	Margin source selection of DTS (Sensor) Based fan control. 1: Margin is provided by CPU directly 0: Margin is calculated by NCT7904D
4	Enable Get DRAM Temperature 1: Enable 0: Disable (Default)
3-2	Reserved
1-0	Running Time Average algorithm has been involved in CPU power reporting. $00_{BIN} = Power_{N+1} = Power_Inst$ $01_{BIN} = Power_{N+1} = (Power_N \cdot \frac{1}{2}) + (Power_Inst \cdot \frac{1}{2})$ $10_{BIN} = Power_{N+1} = (Power_N \cdot \frac{3}{4}) + (Power_Inst \cdot \frac{1}{4})$ $11_{BIN} = Power_{N+1} = (Power_N \cdot \frac{7}{8}) + (Power_Inst \cdot \frac{1}{8})$

7.3.11 Averaging DTS Based Thermal Spec Configure Register (ADBTSC)

Location:

- Alpha_f** - Bank 2 Address 0D_{HEX}
- Alpha_s** - Bank 2 Address 0E_{HEX}
- Factor_C** - Bank 2 Address 0F_{HEX}

Type: Read / Write

Reset: Power On Reset
RESETIN# with LOCK=0

Alpha_f / Alpha_s / Factor_C

BIT	7	6	5	4	3	2	1	0
NAME	Alpha_f / Alpha_s / Factor_C							
DEFAULT	FF _{HEX} / 12 _{HEX} / 62 _{HEX}							

BIT	DESCRIPTION
7-0	<p>Alpha_f / Alpha_s: the time constant coefficient (unit : 1/second) Factor_C: The scale factor for each average</p> <p>The averaging formula is as following. $Tdts_f = Alpha_f \times Tdts_max + Tdts_f_previous \times (1 - Alpha_f)$ $Tdts_s = Alpha_s \times Tdts_max + Tdts_s_previous \times (1 - Alpha_s)$ $Tdts_ave = Factor_C \times Tdts_f + (1 - Factor_C) \times Tdts_s$</p> <p>Where: Tdts_max is the instantaneous DTS Based Thermal Spec. NCT7904D will automatically calculate it. Tdts_f_previous is the previous value of Tdts_f. Tdts_s_previous is the previous value of Tdts_s.</p> <p>The parameter value is to sum up each bit weighting. The weighting of each bit is defined as following. [7] = 0.5 [6] = 0.25 [5] = 0.125 [4] = 0.0625 [3] = 0.03125 [2] = 0.015625 [1] = 0.0078125 [0] = 0.00390625</p>

7.3.12 PECl Manual Mode Configure Register (PMMC)

Location:

- Address** - Bank 2 Address 10_{HEX}
- Write_Length** - Bank 2 Address 11_{HEX}
- Read_Length** - Bank 2 Address 12_{HEX}
- Command_Code** - Bank 2 Address 13_{HEX}

Type: Read / Write

Reset: Power On Reset
 RESETIN# with LOCK=0

PMMC

BIT	7	6	5	4	3	2	1	0
NAME	Address							
DEFAULT	00 _{HEX}							

BIT	7	6	5	4	3	2	1	0
NAME	Write Length							
DEFAULT	00 _{HEX}							

BIT	7	6	5	4	3	2	1	0
NAME	Read Length							
DEFAULT	00 _{HEX}							

BIT	7	6	5	4	3	2	1	0
NAME	Command Code							
DEFAULT	00 _{HEX}							

BIT	DESCRIPTION							
7-0	These settings are necessary while manual mode transaction is required. Please refer to formal PECl spec for more information on them. It should be setup in advance before Manual Mode enable (Bank 2 Address 00 _{HEX} Bit[2] =1),							

7.3.13 PECl Manual Mode Write Data Register (PMMWD)

Location:

- PMMWD 1** - Bank 2 Address 14_{HEX}
- PMMWD 2** - Bank 2 Address 15_{HEX}
- PMMWD 3** - Bank 2 Address 16_{HEX}
- PMMWD 4** - Bank 2 Address 17_{HEX}
- PMMWD 5** - Bank 2 Address 18_{HEX}
- PMMWD 6** - Bank 2 Address 19_{HEX}
- PMMWD 7** - Bank 2 Address 1A_{HEX}
- PMMWD 8** - Bank 2 Address 1B_{HEX}
- PMMWD 9** - Bank 2 Address 1C_{HEX}
- PMMWD 10** - Bank 2 Address 1D_{HEX}
- PMMWD 11** - Bank 2 Address 1E_{HEX}
- PMMWD 12** - Bank 2 Address 1F_{HEX}

Type: Read / Write
 Reset: Power On Reset
 RESETIN# with LOCK=0

PMMWD1 ~ PMMWD12

BIT	7	6	5	4	3	2	1	0
NAME	Write Data 1 ~ Write Data 12							
DEFAULT	00 _{HEX}							

BIT	DESCRIPTION
7-0	These settings are necessary while manual mode transaction is required. Please refer to formal PECl spec for more information on them. It should be setup in advance before Manual Mode enable (Bank 2 Address 00 _{HEX} Bit[2] =1),

7.3.14 PECl Manual Mode Read Data Register (PMMRD)

Location:

- PMMRD 1** - Bank 2 Address 20_{HEX}
- PMMRD 2** - Bank 2 Address 21_{HEX}
- PMMRD 3** - Bank 2 Address 22_{HEX}
- PMMRD 4** - Bank 2 Address 23_{HEX}
- PMMRD 5** - Bank 2 Address 24_{HEX}
- PMMRD 6** - Bank 2 Address 25_{HEX}
- PMMRD 7** - Bank 2 Address 26_{HEX}
- PMMRD 8** - Bank 2 Address 27_{HEX}
- PMMRD 9** - Bank 2 Address 28_{HEX}

Type: Read Only
 Reset: Power On Reset

PMMRD1 ~ PMMRD9

BIT	7	6	5	4	3	2	1	0
NAME	Read Data 1 ~ Read Data 9							
DEFAULT	00 _{HEX}							

BIT	DESCRIPTION
7-0	These data are meaningful just after manual mode transaction is finished. Please refer to formal PECL spec for more information on them.

PECL Manual Mode Support Command and Data

Command Bank 2	Address CR 10 _{HEX}	Write Length CR 11 _{HEX}	Read Length CR 12 _{HEX}	Command Code CR 13 _{HEX}
Ping	30/ 31/ 32/ 33	00	00	
Get DIB		01	08	F7
Get Temp		01	02	01
PCIRd30		06	02 / 03 / 05	61
PCIWr30		08 / 09 / 0B	01	65
PCIRdLocal30		05	02 / 03 / 05	E1
PCIWrLocal30		07 / 08 / 0A	01	E5
PKGRd30		05	02 / 03 / 05	A1
PKGWr30		07 / 08 / 0A	01	A5
IAMSRrd30		05	02 / 03 / 05 / 09	B1
IAMSRWr30		07 / 08 / 0A / 0E	01	B5

PECL Manual Mode Read Data Table

Command	PCI Rd30	PCI Wr30	PCIRd Local30	PCIWr Local30	PKG Rd30	PKG Wr30	IAMSR Rd30	IAMSR Wr30	GetDIB	GetTemp
Command Code	61	65	E1	E5	A1	A5	B1	B5	F7	01
RdData 1 CR 20 _{HEX}	Ccode	Ccode	Ccode	Ccode	Ccode	Ccode	Ccode	Ccode	*	*
RdData 2 CR 21 _{HEX}	*	*	*	*	*	*	Data LSB_1	*	Device Info	*
RdData 3 CR 22 _{HEX}	*	*	*	*	*	*	Data LSB_2	*	Revision Number	*
RdData 4 CR 23 _{HEX}	*	*	*	*	*	*	Data LSB_3	*	Reserved 1	*
RdData 5	*	*	*	*	*	*	Data	*	Reserved	*

Command	PCI Rd30	PCI Wr30	PCIRd Local30	PCIWr Local30	PKG Rd30	PKG Wr30	IAMSR Rd30	IAMSR Wr30	GetDIB	GetTemp
CR 24 _{HEX}							LSB_4		2	
RdData 6 CR 25 _{HEX}	Data LSB_1	*	Data LSB_1	*	Data LSB_1	*	Data LSB_5	*	Reserved 3	*
RdData 7 CR 26 _{HEX}	Data LSB_2	*	Data LSB_2	*	Data LSB_2	*	Data LSB_6	*	Reserved 4	*
RdData 8 CR 27 _{HEX}	Data LSB_3	*	Data LSB_3	*	Data LSB_3	*	Data LSB_7	*	Reserved 5	Temp_LB
RdData 9 CR 28 _{HEX}	Data MSB	*	Data MSB	*	Data MSB	*	Data MSB	*	Reserved 6	Temp_HB

*mean do not care

PECI Manual Command Write Data Table

Command	PCI Rd30	PCI Wr30	PCIRd Local30	PCIWr Local30	PKG Rd30	PKG Wr30	IAMSR Rd30	IAMSR Wr30
Command Code	61	65	E1	E5	A1	A5	B1	B5
WrData 1 CR 14 _{HEX}	Host ID	Host ID	Host ID	Host ID	Host ID	Host ID	Host ID	Host ID
WrData 2 CR 15 _{HEX}	Addr LSB_1	Addr LSB_1	Addr LSB_1	Addr LSB_1	Index	Index	Processor ID	Processor ID
WrData 3 CR 16 _{HEX}	Addr LSB_2	Addr LSB_2	Addr LSB_2	Addr LSB_2	Param LSB	Param LSB	Addr LSB	Addr LSB
WrData 4 CR 17 _{HEX}	Addr LSB_3	Addr LSB_3	Addr MSB	Addr MSB	Param MSB	Param MSB	Addr MSB	Addr MSB
WrData 5 CR 18 _{HEX}	Addr MSB	Addr MSB	*	Data LSB_1	*	Data LSB_1	*	Data LSB_1
WrData 6 CR 19 _{HEX}	*	Data LSB_1	*	Data LSB_2	*	Data LSB_2	*	Data LSB_2
WrData 7 CR 1A _{HEX}	*	Data LSB_2	*	Data LSB_3	*	Data LSB_3	*	Data LSB_3
WrData 8 CR 1B _{HEX}	*	Data LSB_3	*	Data MSB	*	Data MSB	*	Data LSB_4
WrData 9 CR 1C _{HEX}	*	Data MSB	*	*	*	*	*	Data LSB_5
WrData10 CR 1D _{HEX}	*	*	*	*	*	*	*	Data LSB_6
WrData11 CR 1E _{HEX}	*	*	*	*	*	*	*	Data LSB_7

Command	PCI Rd30	PCI Wr30	PCIRd Local30	PCIWr Local30	PKG Rd30	PKG Wr30	IAMSR Rd30	IAMSR Wr30
WrData12 CR 1F _{HEX}	*	*	*	*	*	*	*	Data MSB

*mean do not care

7.3.15 Agent Relative Temperature Registers (ARTR)

Location:

- A0D0RTH** - Bank 2 Address 30_{HEX}
- A0D0RTL** - Bank 2 Address 31_{HEX}
- A0D1RTH** - Bank 2 Address 32_{HEX}
- A0D1RTL** - Bank 2 Address 33_{HEX}
- A1D0RTH** - Bank 2 Address 34_{HEX}
- A1D0RTL** - Bank 2 Address 35_{HEX}
- A1D1RTH** - Bank 2 Address 36_{HEX}
- A1D1RTL** - Bank 2 Address 37_{HEX}
- A2D0RTH** - Bank 2 Address 38_{HEX}
- A2D0RTL** - Bank 2 Address 39_{HEX}
- A2D1RTH** - Bank 2 Address 3A_{HEX}
- A2D1RTL** - Bank 2 Address 3B_{HEX}
- A3D0RTH** - Bank 2 Address 3C_{HEX}
- A3D0RTL** - Bank 2 Address 3D_{HEX}
- A3D1RTH** - Bank 2 Address 3E_{HEX}
- A3D1RTL** - Bank 2 Address 3F_{HEX}

Type: Read Only

Reset: Power On Reset

BIT	15	14	13	12	11	10	9	8
NAME	A0D0RTH – A3D0RTH : Agent 0- Agent 3 Domain0 Relative Temperature High byte A0D1RTH – A3D1RTH : Agent 0- Agent 3 Domain1 Relative Temperature High byte Refer the <u>PECI Temperature format</u> to calculate temperature data.							
	Sign	Temperature[8:2]						
DEFAULT	F8 _{HEX}							

BIT	7	6	5	4	3	2	1	0
NAME	A0D0RTL – A3D0RTL : Agent 0- Agent 3 Domain0 Relative Temperature Low byte A0D1RTL – A3D1RTL : Agent 0- Agent 3 Domain1 Relative Temperature Low byte Refer the <u>PECI Temperature format</u> to calculate temperature data.							
	Temperature[1:0]	TEMP_2	TEMP_4	TEMP_8	TEMP_16	TEMP_32	TEMP_64	TEMP_128
DEFAULT	80 _{HEX}							

GetTemp() PECE Temperature format:

BIT	DESCRIPTION
15	Sign Bit. (Sign) In PECE Protocol, this bit should always be 1 to represent a negative temperature.
14-6	The integer part of the relative temperature. (Temperature[8:0])
5	TEMP_2. 0.5°C unit.
4	TEMP_4. 0.25°C unit.
3	TEMP_8. 0.125°C unit.
2	TEMP_16. 0.0625°C unit.
1	TEMP_32. 0.03125°C unit.
0	TEMP_64. 0.015625°C unit.

GetTemp() Response Definition:

RESPONSE	MEANING
General Sensor Error (GSE)	Thermal scan did not complete in time. Retry is appropriate.
0x0000	Processor is running at its maximum temperature or is currently being reset.
All other data	Valid temperature reading, reported as a negative offset from the TCC activation temperature. The valide temperature reading is referred to <u>GetTemp() PECE Temperature format</u>

On some occasions, PECE will return the abnormal states of the PECE bus in addition to the temperature. All the information will be recorded. In some cases, the NCT7904D will also do further processing for the alert mechanism. The following describes these codes and their effects to the NCT7904D.

Error Code	Description	NCT7904D host operation
8000 _{HEX}	General Sensor Error	No further processing.
8001 _{HEX}	Sensing Device Missing	
8002 _{HEX}	Operational, but the temperature is lower than the sensor operation range (underflow).	Compulsorily write -128°C back to the temperature readouts.
8003 _{HEX}	Operational, but the temperature is higher than the sensor operation range. (overflow)	compulsorily write 127°C back to the temperature readouts.
8004 _{HEX} 81FF _{HEX}	Reserved.	No further operation.

7.3.16 TSI Control Registers

Location: Bank 2 Address 50_{HEX}
 Type: Read / Write
 Reset: Power On Reset
 RESETIN# with LOCK=0
 Default Value: 00_{HEX}

BIT	DESCRIPTION
7	EN_TSI – Enable TSI function (* Set Bank2 Addr[53h] to 00h , before set EN_TSI=1) 0 = Disable 1 = Enable
6	LSN_MD – Enable TSI Listening function 0 = Disable 1 = Enable (Listened temperatures will override the CPU temperatures)
5-4	TSI_SPD[1:0] – TSI channel speed 00 _{BIN} = 250KHz 01 _{BIN} = 100KHz 10 _{BIN} = 50KHz 11 _{BIN} = 10KHz
3-0	Reserved

7.3.17 TSI Client Enable Registers

Location: Bank 2 Address 51_{HEX}
 Type: Read / Write
 Reset: Power On Reset
 RESETIN# with LOCK=0
 Default Value: FF_{HEX}

BIT	DESCRIPTION
7-0	EN_CLIENT[7:0] – Enable TSI clients 0 = Disable 1 = Enable

7.3.18 TSI Manual Configuration Registers

Location: Bank 2 Address 52_{HEX}
 Type: Read / Write
 Reset: Power On Reset
 RESETIN# with LOCK=0
 Default Value: 08_{HEX}

BIT	DESCRIPTION
7	EN_MANU – Enable TSI manual mode 0 = Disable 1 = Enable
6	MANU_RNW – TSI manual read / write 0 = Write

BIT	DESCRIPTION
	1 = Read
5	MANU_STEP – Enable TSI manual mode Set to do manual command one time then auto be cleared
4	MANU_STS – Report TSI Status (Read Only) 0 = Transaction OK 1 = Transaction fail
3	MANU_DONE – TSI Manual Done Status (Read Only) 0 = Transaction done 1 = Transaction still processing
2-0	Reserved

7.3.19 TSI Test Mode Registers

Location: Bank 2 Address 53_{HEX}

Type: Read / Write

Reset: Power On Reset
RESETIN# with LOCK=0

Default Value: 02_{HEX}

BIT	DESCRIPTION
7-0	Internal Test Mode Register[7:0] – Set this register to 00h before enable TSI function.

7.3.20 TSI Manual Address Registers

Location: Bank 2 Address 54_{HEX}

Type: Read / Write

Reset: Power On Reset
RESETIN# with LOCK=0

Default Value: 00_{HEX}

BIT	DESCRIPTION
7-0	MANU_ADDR[7:0] – TSI manual command address

7.3.21 TSI Manual Command Registers

Location: Bank 2 Address 55_{HEX}

Type: Read / Write

Reset: Power On Reset
RESETIN# with LOCK=0

Default Value: 00_{HEX}

BIT	DESCRIPTION
7-0	MANU_CMD[7:0] – TSI manual command data

7.3.22 TSI Manual Write Data Registers

Location: Bank 2 Address 56_{HEX}
 Type: Read / Write
 Reset: Power On Reset
 RESETIN# with LOCK=0
 Default Value: 00_{HEX}

BIT	DESCRIPTION
7-0	MANU_WDATA[7:0] – TSI manual write data

7.3.23 TSI Manual Read Data Registers

Location: Bank 2 Address 57_{HEX}
 Type: Read Only
 Reset: Power On Reset
 Default Value: 00_{HEX}

BIT	DESCRIPTION
7-0	MANU_RDATA[7:0] – TSI manual read data

7.3.24 PCH Read Control Registers

Location: Bank 2 Address 60_{HEX}
 Type: Read / Write
 Reset: Power On Reset
 RESETIN# with LOCK=0
 Default Value: 20_{HEX}

BIT	DESCRIPTION
7	EN_PCH_RD – Enable PCH read function 0 = Disable 1 = Enable
6	Reserved
5-4	PCH_RD_SPD[1:0] – PCH channel read speed 00 _{BIN} = 250KHz 01 _{BIN} = 100KHz 10 _{BIN} = 50KHz 11 _{BIN} = 10KHz
3-0	Reserved

7.3.25 PCH Client Address Registers

Location: Bank 2 Address 61_{HEX}
 Type: Read / Write
 Reset: Power On Reset
 RESETIN# with LOCK=0
 Default Value: 00_{HEX}

BIT	DESCRIPTION
7-0	PCH_ADDR[7:0] – PCH client address

7.3.26 PCH Command Registers

Location: Bank 2 Address 62_{HEX}

Type: Read / Write

Reset: Power On Reset
RESETIN# with LOCK=0

Default Value: 00_{HEX}

BIT	DESCRIPTION
7-0	PCH_CMD[7:0] – PCH command data

7.3.27 PCH Read Byte Count Registers

Location: Bank 2 Address 63_{HEX}

Type: Read Only

Reset: Power On Reset

Default Value: 00_{HEX}

BIT	DESCRIPTION
7-0	PCH_BYTE_CNT[7:0] – PCH read byte count

7.3.28 SMBUS Master Manual Configuration Registers

Location: Bank 2 Address 64_{HEX}

Type: Read / Write

Reset: Power On Reset
RESETIN# with LOCK=0

Default Value: 08_{HEX}

BIT	DESCRIPTION
7	EN_SM_MANU – Enable SMBUS Master manual mode 0 = Disable 1 = Enable
6	SM_RNW – SMBUS Master manual read / write 0 = Write 1 = Read
5	SM_STEP – Enable SMBUS Master manual mode Set to do manual command one time then auto be cleared
4	SM_STS – Report SMBUS Master Status (Read Only) 0 = Transaction OK 1 = Transaction fail
3	SM_DONE – SMBUS Master Manual Done Status (Read Only) 0 = Transaction done 1 = Transaction still processing
2-0	Reserved

7.3.29 SMBUS Master Manual Address Registers

Location: Bank 2 Address 65_{HEX}
 Type: Read / Write
 Reset: Power On Reset
 RESETIN# with LOCK=0
 Default Value: 00_{HEX}

BIT	DESCRIPTION
7-0	SM_ADDR[7:0] – SMBUS Master manual command address

7.3.30 SMBUS Master Manual Command Registers

Location: Bank 2 Address 66_{HEX}
 Type: Read / Write
 Reset: Power On Reset
 RESETIN# with LOCK=0
 Default Value: 00_{HEX}

BIT	DESCRIPTION
7-0	SM_CMD[7:0] – SMBUS Master manual command data

7.3.31 SMBUS Master Manual Write Data Registers

Location: Bank 2 Address 67_{HEX}
 Type: Read / Write
 Reset: Power On Reset
 RESETIN# with LOCK=0
 Default Value: 00_{HEX}

BIT	DESCRIPTION
7-0	SM_WDATA[7:0] – SMBUS Master manual write data

7.3.32 SMBUS Master Manual Read Data Registers

Location: Bank 2 Address 68_{HEX}
 Type: Read Only
 Reset: Power On Reset
 Default Value: 00_{HEX}

BIT	DESCRIPTION
7-0	SM_RDATA[7:0] – SMBUS Master manual read data

7.3.33 External Read Control Registers

Location: Bank 2 Address 6A_{HEX}
 Type: Read / Write
 Reset: Power On Reset
 RESETIN# with LOCK=0
 Default Value: 00_{HEX}

BIT	DESCRIPTION
7	EN_EXT_RD – Enable External Read function.

BIT	DESCRIPTION
	0 = Disable 1 = Enable
6-4	Reserved
3	EN_EXT_P3 – Enable EXT_P3 read function. 0 = Disable 1 = Enable
2	EN_EXT_P2 – Enable EXT_P2 read function. 0 = Disable 1 = Enable
1	EN_EXT_P1 – Enable EXT_P1 read function. 0 = Disable 1 = Enable
0	EN_EXT_P0 – Enable EXT_P0 read function. 0 = Disable 1 = Enable

7.3.34 External Read Address and Command Register

Location:

- EXT_ADDR_P0** - Bank 0 Address 6C_{HEX}
- EXT_CMD_P0** - Bank 0 Address 6D_{HEX}
- EXT_ADDR_P1** - Bank 0 Address 6E_{HEX}
- EXT_CMD_P1** - Bank 0 Address 6F_{HEX}
- EXT_ADDR_P2** - Bank 0 Address 70_{HEX}
- EXT_CMD_P2** - Bank 0 Address 71_{HEX}
- EXT_ADDR_P3** - Bank 0 Address 72_{HEX}
- EXT_CMD_P3** - Bank 0 Address 73_{HEX}

Type: Read / Write

Reset: Power On Reset
RESETIN# with LOCK=0

EXT_ADDR_P0 – Port 0 external SMBUS address

Location: Bank 2 Address 6C_{HEX}

Default Value: 00_{HEX}

BIT	DESCRIPTION
7-0	EXT_ADDR_P0 – Port 0 external SMBUS address

EXT_CMD_P0 – Port 0 external SMBUS command

Location: Bank 2 Address 6D_{HEX}

Default Value: 00_{HEX}

BIT	DESCRIPTION
7-0	EXT_CMD_P0 – Port 0 external SMBUS command

EXT_ADDR_P1 – Port 1 external SMBUS address

Location: Bank 2 Address 6E_{HEX}

Default Value: 00_{HEX}

BIT	DESCRIPTION
7-0	EXT_ADDR_P1 – Port 1 external SMBUS address

EXT_CMD_P1 – Port 1 external SMBUS command

Location: Bank 2 Address 6F_{HEX}

Default Value: 00_{HEX}

BIT	DESCRIPTION
7-0	EXT_CMD_P1 – Port 1 external SMBUS command

EXT_ADDR_P2 – Port 2 external SMBUS address

Location: Bank 2 Address 70_{HEX}

Default Value: 00_{HEX}

BIT	DESCRIPTION
7-0	EXT_ADDR_P2 – Port 2 external SMBUS address

EXT_CMD_P2 – Port 2 external SMBUS command

Location: Bank 2 Address 71_{HEX}

Default Value: 00_{HEX}

BIT	DESCRIPTION
7-0	EXT_CMD_P2 – Port 2 external SMBUS command

EXT_ADDR_P3 – Port 3 external SMBUS address

Location: Bank 2 Address 72_{HEX}

Default Value: 00_{HEX}

BIT	DESCRIPTION
7-0	EXT_ADDR_P3 – Port 3 external SMBUS address

EXT_CMD_P3 – Port 3 external SMBUS command

Location: Bank 2 Address 73_{HEX}

Default Value: 00_{HEX}

BIT	DESCRIPTION
7-0	EXT_CMD_P3 – Port 3 external SMBUS command

7.3.35 Power Unit Status

Location: Bank 2 Address 80_{HEX}

Type: Read / Write

Reset: Power On Reset
RESETIN# with LOCK=0

Power_Unit

BIT	7	6	5	4	3	2	1	0
NAME	Reserved				Power_Unit[3:0]			
DEFAULT	03 _{HEX}							

BIT	DESCRIPTION
7-4	Reserved

BIT	DESCRIPTION
3-0	Power_Unit[3:0] – Unit index for power data retrieved from CPU over PECI The calculation of unit is $1W / 2^{\text{Power_Unit}}$. Default is 03h. The manufacture setting will be loaded into as soon as PECI_En assertion. However user could override it by anytime.

7.3.36 Energy Unit Status

Location: Bank 2 Address 81_{HEX}
 Type: Read / Write
 Reset: Power On Reset
 RESETIN# with LOCK=0

Energy_Unit

BIT	7	6	5	4	3	2	1	0
NAME	Reserved			Energy_Unit[4:0]				
DEFAULT	10 _{HEX}							

BIT	DESCRIPTION
7-5	Reserved
4-0	Energy_Unit[4:0] – Unit index for energy data retrieved from CPU over PECI The calculation of unit is $1J / 2^{\text{Energy_Unit}}$. Default is 10h. The manufacture setting will be loaded into as soon as PECI_En assertion. However user could override it by anytime.

7.3.37 Retrieving Margin Status Control Registers

Location: **CFG** - Bank 2 Address 84_{HEX}
 Type: Read / Write
 Reset: Power On Reset
 RESETIN# with LOCK=0

CFG

BIT	7	6	5	4	3	2	1	0
NAME	Reserved						MARGIN_BSEL[1:0]	
DEFAULT	00 _{HEX}							

BIT	DESCRIPTION
7-2	Reserved
1-0	MARGIN_BSEL[1:0] : Pick-up selection of margin value among returned four bytes data from RdPkgConfig(). The pick-up data will be put into CR98 ~ CR9B Bit[1:0] = 11 => Select last retrieved byte, MSB Bit[1:0] = 10 => Select 3 rd retrieved byte Bit[1:0] = 01 => Select second retrieved byte Bit[1:0] = 00 => Select first retrieved byte, LSB

Location:

MARGIN_INDEX - Bank 2 Address 85_{HEX}

Type: Read / Write

Reset: Power On Reset
RESETIN# with LOCK=0

Default: 00_{HEX}

BIT	DESCRIPTION
7-0	MARGIN_INDEX : Index data for executing RdPkgConfig()

Location:

MARGIN_PARA_L - Bank 2 Address 86_{HEX}

Type: Read / Write

Reset: Power On Reset
RESETIN# with LOCK=0

Default: 00_{HEX}

BIT	DESCRIPTION
7-0	MARGIN_PARA_L : Low byte of parameter data for executing RdPkgConfig()

Location:

MARGIN_PARA_H - Bank 2 Address 87_{HEX}

Type: Read / Write

Reset: Power On Reset
RESETIN# with LOCK=0

Default: 00_{HEX}

BIT	DESCRIPTION
7-0	MARGIN_PARA_H : High byte of parameter data for executing RdPkgConfig()

7.3.38 Tjmax Temperature Target Read/Write for CPU Agent (Address : 30h ~ 33h)

Location:

Tjmax_CPU0 - Bank 2 Address 88_{HEX}

Tjmax_CPU1 - Bank 2 Address 89_{HEX}

Tjmax_CPU2 - Bank 2 Address 8A_{HEX}

Tjmax_CPU3 - Bank 2 Address 8B_{HEX}

Type: Read / Write

Reset: Power On Reset
RESETIN# with LOCK=0

BIT	DESCRIPTION
7-0	<p>Tjmax_CPU0[7:0] – Tjmax data for agent address 30h Tjmax_CPU1[7:0] – Tjmax data for agent address 31h Tjmax_CPU2[7:0] – Tjmax data for agent address 32h Tjmax_CPU3[7:0] – Tjmax data for agent address 33h The manufacture setting will be loaded into as soon as PECl_En assertion. However user could override it by anytime.</p>

BIT	DESCRIPTION
Default	00 _{HEX}

7.3.39 Tcontrol Temperature Target Read/Write for CPU Agent (Address : 30h ~ 33h)

Location:

Tjmax_CPU0 - Bank 2 Address 8C_{HEX}

Tjmax_CPU1 - Bank 2 Address 8D_{HEX}

Tjmax_CPU2 - Bank 2 Address 8E_{HEX}

Tjmax_CPU3 - Bank 2 Address 8F_{HEX}

Type: Read / Write

Reset: Power On Reset
RESETIN# with LOCK=0

BIT	DESCRIPTION
7-0	Tcontrol_CPU0[7:0] – Tcontrol data for agent address 30h Tcontrol_CPU1[7:0] – Tcontrol data for agent address 31h Tcontrol_CPU2[7:0] – Tcontrol data for agent address 32h Tcontrol_CPU3[7:0] – Tcontrol data for agent address 33h The manufacture setting will be loaded into as soon as PECl_En assertion. However user could override it by anytime.
Default	00 _{HEX}

7.3.40 Thermal Design Power (TDP) Status for CPU Agent (Address : 30h ~ 33h)

Location:

TDP_HB_CPU0 - Bank 2 Address 90_{HEX}

TDP_LB_CPU0 - Bank 2 Address 91_{HEX}

TDP_HB_CPU1 - Bank 2 Address 92_{HEX}

TDP_LB_CPU1 - Bank 2 Address 93_{HEX}

TDP_HB_CPU2 - Bank 2 Address 94_{HEX}

TDP_LB_CPU2 - Bank 2 Address 95_{HEX}

TDP_HB_CPU3 - Bank 2 Address 96_{HEX}

TDP_LB_CPU3 - Bank 2 Address 97_{HEX}

Type: Read / Write

Reset: Power On Reset
RESETIN# with LOCK=0

TDP_HB_CPUx

BIT	7	6	5	4	3	2	1	0
NAME	Reserved	TDP_HB_CPUx[6:0]						
DEFAULT	00 _{HEX}							

BIT	DESCRIPTION
7	Reserved
6-0	High Byte Data of TDP[14:8]

BIT	DESCRIPTION
	The manufacture setting will be loaded into as soon as PECl_En assertion. However user could override it by anytime.

TDP_LB_CPUx

BIT	7	6	5	4	3	2	1	0
NAME	TDP_HB_CPUx							
DEFAULT	00 _{HEX}							

BIT	DESCRIPTION
7-0	Low Byte Data of TDP[7:0] The manufacture setting will be loaded into as soon as PECl_En assertion. However user could override it by anytime.

7.3.41 Margin Status for CPU Agent (Address : 30h ~ 33h)

Location:

Margin_CPU1 - Bank 2 Address 98_{HEX}

Margin_CPU2 - Bank 2 Address 99_{HEX}

Margin_CPU3 - Bank 2 Address 9A_{HEX}

Margin_CPU4 - Bank 2 Address 9B_{HEX}

Type: Read

Reset: Power On Reset

RESETIN# with LOCK=0

Margin_CPUx

BIT	7	6	5	4	3	2	1	0
NAME	Margin_CPUx							
DEFAULT	00 _{HEX}							

BIT	DESCRIPTION
7-0	Margin status for DTS (Sensor) Based Thermal Spec. If Margin is positive, then CPU die temperature is in relative safe operating region. If margin is negative, then CPU is working with higher temperature risk.

7.3.42 Power Reporting Factor for CPU Agent (Address : 30h ~ 33h)

Location:

Factor_CPU1 - Bank 2 Address 9C_{HEX}

Factor_CPU2 - Bank 2 Address 9D_{HEX}

Factor_CPU3 - Bank 2 Address 9E_{HEX}

Factor_CPU4 - Bank 2 Address 9F_{HEX}

Type: Read

Reset: Power On Reset

RESETIN# with LOCK=0

Factor_CPUx

BIT	7	6	5	4	3	2	1	0
NAME	Factor_CPUx							
DEFAULT	FF _{HEX}							

BIT	DESCRIPTION
7-0	<p>Factor_CPUx : Power reporting factor. Power reported over PECI is always higher than actual power. The Factor is to sum up each bit weighting. The weighting of each bit is defined as following. [7] = 0.5 [6] = 0.25 [5] = 0.125 [4] = 0.0625 [3] = 0.03125 [2] = 0.015625 [1] = 0.0078125 [0] = 0.00390625</p>

7.3.43 DTS DRAM Temperature Monitor Enable Control Register

Location:

EN_MT_CTRL0 - Bank 2 Address C0_{HEX}

EN_MT_CTRL1 - Bank 2 Address C1_{HEX}

EN_T_DM_CTRL - Bank 2 Address C2_{HEX}

Type: Read / Write

Reset: Power On Reset
 RESETIN# with LOCK=0

EN_MT_CTRL0 – Digital Channel Highest Temperature Monitoring Control Register

Location: Bank 2 Address C0_{HEX}

Default Value: 00_{HEX}

BIT	DESCRIPTION
7	<p>EN_MT_C3_C1 – Enable DTS CPU1 Channel3 highest DIMM temperature monitoring. 0 = Disable 1 = Enable</p>
6	<p>EN_MT_C2_C1 – Enable DTS CPU1 Channel2 highest DIMM temperature monitoring. 0 = Disable 1 = Enable</p>
5	<p>EN_MT_C1_C1 – Enable DTS CPU1 Channel1 highest DIMM temperature monitoring. 0 = Disable 1 = Enable</p>
4	<p>EN_MT_C0_C1 – Enable DTS CPU1 Channel0 highest DIMM temperature monitoring. 0 = Disable 1 = Enable</p>
3	<p>EN_MT_C3_C0 – Enable DTS CPU0 Channel3 highest DIMM temperature monitoring. 0 = Disable</p>

BIT	DESCRIPTION
	1 = Enable
2	EN_MT_C2_C0 – Enable DTS CPU0 Channel2 highest DIMM temperature monitoring. 0 = Disable 1 = Enable
1	EN_MT_C1_C0 – Enable DTS CPU0 Channel1 highest DIMM temperature monitoring. 0 = Disable 1 = Enable
0	EN_MT_C0_C0 – Enable DTS CPU0 Channel0 highest DIMM temperature monitoring. 0 = Disable 1 = Enable

EN_MT_CTRL1 – Digital Channel Highest Temperature Monitoring Control Register

Location: Bank 2 Address C1_{HEX}

Default Value: 00_{HEX}

BIT	DESCRIPTION
7-3	Reserved
2	EN_MT_SYS – Enable DTS CPU0 and CPU1 highest DIMM temperature monitoring. 0 = Disable 1 = Enable
1	EN_MT_C1 – Enable DTS CPU1 highest DIMM temperature monitoring. 0 = Disable 1 = Enable
0	EN_MT_C0 – Enable DTS CPU0 highest DIMM temperature monitoring. 0 = Disable 1 = Enable

EN_T_DM_CTRL – Digital DIMM Temperature Monitoring Control Register

Location: Bank 2 Address C2_{HEX}

Default Value: 00_{HEX}

BIT	DESCRIPTION
7	EN_T_C3_C1 – Enable DTS CPU1 Channel3 DIMMs temperature monitoring. 0 = Disable 1 = Enable
6	EN_T_C2_C1 – Enable DTS CPU1 Channel2 DIMMs temperature monitoring. 0 = Disable 1 = Enable
5	EN_T_C1_C1 – Enable DTS CPU1 Channel1 DIMMs temperature monitoring. 0 = Disable 1 = Enable
4	EN_T_C0_C1 – Enable DTS CPU1 Channel0 DIMMs temperature monitoring. 0 = Disable 1 = Enable
3	EN_T_C3_C0 – Enable DTS CPU0 Channel3 DIMMs temperature monitoring. 0 = Disable

BIT	DESCRIPTION
	1 = Enable
2	EN_T_C2_C0 – Enable DTS CPU0 Channel2 DIMMs temperature monitoring. 0 = Disable 1 = Enable
1	EN_T_C1_C0 – Enable DTS CPU0 Channel1 DIMMs temperature monitoring. 0 = Disable 1 = Enable
0	EN_T_C0_C0 – Enable DTS CPU0 Channel0 DIMMs temperature monitoring. 0 = Disable 1 = Enable

7.3.44 DRAM Temperature Value Register (Reterived by PECl RdPkgConfig command)

Location:

- MT_C0_C0** - Bank 2 Address C4_{HEX}
- MT_C1_C0** - Bank 2 Address C5_{HEX}
- MT_C2_C0** - Bank 2 Address C6_{HEX}
- MT_C3_C0** - Bank 2 Address C7_{HEX}
- MT_C0_C1** - Bank 2 Address C8_{HEX}
- MT_C1_C1** - Bank 2 Address C9_{HEX}
- MT_C2_C1** - Bank 2 Address CA_{HEX}
- MT_C3_C1** - Bank 2 Address CB_{HEX}
- MT_C0** - Bank 2 Address CC_{HEX}
- MT_C1** - Bank 2 Address CD_{HEX}
- MT_SYS** - Bank 2 Address CE_{HEX}
- T_D0C0_C0** - Bank 2 Address D0_{HEX}
- T_D1C0_C0** - Bank 2 Address D1_{HEX}
- T_D2C0_C0** - Bank 2 Address D2_{HEX}
- EN_C0_C0** - Bank 2 Address D3_{HEX}
- T_D0C1_C0** - Bank 2 Address D4_{HEX}
- T_D1C1_C0** - Bank 2 Address D5_{HEX}
- T_D2C1_C0** - Bank 2 Address D6_{HEX}
- EN_C1_C0** - Bank 2 Address D7_{HEX}
- T_D0C2_C0** - Bank 2 Address D8_{HEX}
- T_D1C2_C0** - Bank 2 Address D9_{HEX}
- T_D2C2_C0** - Bank 2 Address DA_{HEX}
- EN_C2_C0** - Bank 2 Address DB_{HEX}
- T_D0C3_C0** - Bank 2 Address DC_{HEX}
- T_D1C3_C0** - Bank 2 Address DD_{HEX}
- T_D2C3_C0** - Bank 2 Address DE_{HEX}
- EN_C3_C0** - Bank 2 Address DF_{HEX}
- T_D0C0_C1** - Bank 2 Address E0_{HEX}
- T_D1C0_C1** - Bank 2 Address E1_{HEX}
- T_D2C0_C1** - Bank 2 Address E2_{HEX}
- EN_C0_C1** - Bank 2 Address E3_{HEX}

- T_D0C1_C1 - Bank 2 Address E4_{HEX}
- T_D1C1_C1 - Bank 2 Address E5_{HEX}
- T_D2C1_C1 - Bank 2 Address E6_{HEX}
- EN_C1_C1 - Bank 2 Address E7_{HEX}
- T_D0C2_C1 - Bank 2 Address E8_{HEX}
- T_D1C2_C1 - Bank 2 Address E9_{HEX}
- T_D2C2_C1 - Bank 2 Address EA_{HEX}
- EN_C2_C1 - Bank 2 Address EB_{HEX}
- T_D0C3_C1 - Bank 2 Address EC_{HEX}
- T_D1C3_C1 - Bank 2 Address ED_{HEX}
- T_D2C3_C1 - Bank 2 Address EE_{HEX}
- EN_C3_C1 - Bank 2 Address EF_{HEX}

Type: Read / Write
 Reset: Power On Reset
 RESETIN# with LOCK=0

MT_C0_C0 – CPU0 Channel0 Highest DIMM Temperature Value Register

Location: Bank 2 Address C4_{HEX}
 Default Value: 00_{HEX}

BIT	DESCRIPTION
7-0	MT_C0_C0 [7:0] CPU0 Channel0 Highest DIMM Temperature

MT_C1_C0 – CPU0 Channel1 Highest DIMM Temperature Value Register

Location: Bank 2 Address C5_{HEX}
 Default Value: 00_{HEX}

BIT	DESCRIPTION
7-0	MT_C1_C0 [7:0] CPU0 Channel1 Highest DIMM Temperature

MT_C2_C0 – CPU0 Channel2 Highest DIMM Temperature Value Register

Location: Bank 2 Address C6_{HEX}
 Default Value: 00_{HEX}

BIT	DESCRIPTION
7-0	MT_C2_C0 [7:0] CPU0 Channel2 Highest DIMM Temperature

MT_C3_C0 – CPU0 Channel3 Highest DIMM Temperature Value Register

Location: Bank 2 Address C7_{HEX}
 Default Value: 00_{HEX}

BIT	DESCRIPTION
7-0	MT_C3_C0 [7:0] CPU0 Channel3 Highest DIMM Temperature

MT_C0_C1 – CPU1 Channel0 Highest DIMM Temperature Value Register

Location: Bank 2 Address C8_{HEX}

Default Value: 00_{HEX}

BIT	DESCRIPTION
7-0	MT_C0_C1 [7:0] CPU1 Channel0 Highest DIMM Temperature

MT_C1_C1 – CPU1 Channel1 Highest DIMM Temperature Value Register

Location: Bank 2 Address C9_{HEX}

Default Value: 00_{HEX}

BIT	DESCRIPTION
7-0	MT_C1_C1 [7:0] CPU1 Channel1 Highest DIMM Temperature

MT_C2_C1 – CPU1 Channel2 Highest DIMM Temperature Value Register

Location: Bank 2 Address CA_{HEX}

Default Value: 00_{HEX}

BIT	DESCRIPTION
7-0	MT_C2_C1 [7:0] CPU1 Channel2 Highest DIMM Temperature

MT_C3_C1 – CPU1 Channel3 Highest DIMM Temperature Value Register

Location: Bank 2 Address CB_{HEX}

Default Value: 00_{HEX}

BIT	DESCRIPTION
7-0	MT_C3_C1 [7:0] CPU1 Channel3 Highest DIMM Temperature

MT_C0 – CPU0 Highest DIMM Temperature Value Register

Location: Bank 2 Address CC_{HEX}

Default Value: 00_{HEX}

BIT	DESCRIPTION
7-0	MT_C0 [7:0] CPU0 Highest DIMM Temperature

MT_C1 – CPU1 Highest DIMM Temperature Value Register

Location: Bank 2 Address CD_{HEX}

Default Value: 00_{HEX}

BIT	DESCRIPTION
7-0	MT_C1 [7:0] CPU1 Highest DIMM Temperature

MT_SYS – CPU0 and CPU1 Highest DIMM Temperature Value Register

Location: Bank 2 Address CE_{HEX}

Default Value: 00_{HEX}

BIT	DESCRIPTION
7-0	MT_SYS [7:0] CPU0 and CPU1 Highest DIMM Temperature

T_DxC0_C0 – CPU0 Channel0 DIMM0~DIMM2 Temperature Value Register

Location: Bank 2 Address D0_{HEX} ~ D2_{HEX}

Default Value: 00_{HEX}

BIT	DESCRIPTION
7-0	T_D0C0_C0 [7:0] ~ T_D2C0_C0 [7:0] T_D0C0_C0 : CPU0 Channel0 DIMM0 Temperature T_D1C0_C0 : CPU0 Channel0 DIMM1 Temperature T_D2C0_C0 : CPU0 Channel0 DIMM2 Temperature

EN_C0_C0 – Enable Read CPU0 Channel0 DIMM Temperature Register

Location: Bank 2 Address D3_{HEX}

Default Value: 07_{HEX}

BIT	DESCRIPTION
7-3	Reserved
2	EN_T_DIMM2_CHO_C0 – Enable DTS CPU0 Channel0 DIMM2 temperature monitoring. 0 = Disable 1 = Enable
1	EN_T_DIMM1_CHO_C0 – Enable DTS CPU0 Channel0 DIMM1 temperature monitoring. 0 = Disable 1 = Enable
0	EN_T_DIMM0_CHO_C0 – Enable DTS CPU0 Channel0 DIMM0 temperature monitoring. 0 = Disable 1 = Enable

T_DxC1_C0 – CPU0 Channel1 DIMM0~DIMM2 Temperature Value Register

Location: Bank 2 Address D4_{HEX} ~ D6_{HEX}

Default Value: 00_{HEX}

BIT	DESCRIPTION
7-0	T_D0C1_C0 [7:0] ~ T_D2C1_C0 [7:0] T_D0C1_C0 : CPU0 Channel1 DIMM0 Temperature T_D1C1_C0 : CPU0 Channel1 DIMM1 Temperature T_D2C1_C0 : CPU0 Channel1 DIMM2 Temperature

EN_C1_C0 – Enable Read CPU0 Channel1 DIMM Temperature Register

Location: Bank 2 Address D7_{HEX}

Default Value: 07_{HEX}

BIT	DESCRIPTION
7-3	Reserved
2	EN_T_DIMM2_CH1_C0 – Enable DTS CPU0 Channel1 DIMM2 temperature monitoring. 0 = Disable 1 = Enable
1	EN_T_DIMM1_CH1_C0 – Enable DTS CPU0 Channel1 DIMM1 temperature monitoring. 0 = Disable 1 = Enable
0	EN_T_DIMM0_CH1_C0 – Enable DTS CPU0 Channel1 DIMM0 temperature monitoring. 0 = Disable 1 = Enable

T_DxC2_C0 – CPU0 Channel2 DIMM0~DIMM2 Temperature Value Register

Location: Bank 2 Address D8_{HEX} ~ DA_{HEX}

Default Value: 00_{HEX}

BIT	DESCRIPTION
7-0	T_D0C2_C0 [7:0] ~ T_D2C2_C0 [7:0] T_D0C2_C0 : CPU0 Channel2 DIMM0 Temperature T_D1C2_C0 : CPU0 Channel2 DIMM1 Temperature T_D2C2_C0 : CPU0 Channel2 DIMM2 Temperature

EN_C2_C0 – Enable Read CPU0 Channel2 DIMM Temperature Register

Location: Bank 2 Address DB_{HEX}

Default Value: 07_{HEX}

BIT	DESCRIPTION
7-3	Reserved
2	EN_T_DIMM2_CH2_C0 – Enable DTS CPU0 Channel2 DIMM2 temperature monitoring. 0 = Disable 1 = Enable
1	EN_T_DIMM1_CH2_C0 – Enable DTS CPU0 Channel2 DIMM1 temperature monitoring. 0 = Disable 1 = Enable
0	EN_T_DIMM0_CH2_C0 – Enable DTS CPU0 Channel2 DIMM0 temperature monitoring. 0 = Disable 1 = Enable

T_DxC3_C0 – CPU0 Channel3 DIMM0~DIMM2 Temperature Value Register

Location: Bank 2 Address DC_{HEX} ~ DE_{HEX}

Default Value: 00_{HEX}

BIT	DESCRIPTION
7-0	T_D0C3_C0 [7:0] ~ T_D2C3_C0 [7:0]

BIT	DESCRIPTION
	T_D0C3_C0 : CPU0 Channel3 DIMM0 Temperature T_D1C3_C0 : CPU0 Channel3 DIMM1 Temperature T_D2C3_C0 : CPU0 Channel3 DIMM2 Temperature

EN_C3_C0 – Enable Read CPU0 Channel3 DIMM Temperature Register

Location: Bank 2 Address DF_{HEX}

Default Value: 07_{HEX}

BIT	DESCRIPTION
7-3	Reserved
2	EN_T_DIMM2_CH3_C0 – Enable DTS CPU0 Channel3 DIMM2 temperature monitoring. 0 = Disable 1 = Enable
1	EN_T_DIMM1_CH3_C0 – Enable DTS CPU0 Channel3 DIMM1 temperature monitoring. 0 = Disable 1 = Enable
0	EN_T_DIMM0_CH3_C0 – Enable DTS CPU0 Channel3 DIMM0 temperature monitoring. 0 = Disable 1 = Enable

T_DxC0_C1 – CPU1 Channel0 DIMM0~DIMM2 Temperature Value Register

Location: Bank 2 Address E0_{HEX} ~ E2_{HEX}

Default Value: 00_{HEX}

BIT	DESCRIPTION
7-0	T_D0C0_C1 [7:0] ~ T_D2C0_C1 [7:0] T_D0C0_C1 : CPU1 Channel0 DIMM0 Temperature T_D1C0_C1 : CPU1 Channel0 DIMM1 Temperature T_D2C0_C1 : CPU1 Channel0 DIMM2 Temperature

EN_C0_C1 – Enable Read CPU1 Channel0 DIMM Temperature Register

Location: Bank 2 Address E3_{HEX}

Default Value: 07_{HEX}

BIT	DESCRIPTION
7-3	Reserved
2	EN_T_DIMM2_CH0_C1 – Enable DTS CPU1 Channel0 DIMM2 temperature monitoring. 0 = Disable 1 = Enable
1	EN_T_DIMM1_CH0_C1 – Enable DTS CPU1 Channel0 DIMM1 temperature monitoring. 0 = Disable 1 = Enable
0	EN_T_DIMM0_CH0_C1 – Enable DTS CPU1 Channel0 DIMM0 temperature monitoring. 0 = Disable 1 = Enable

T_DxC1_C1 – CPU1 Channel1 DIMM0~DIMM2 Temperature Value Register

Location: Bank 2 Address E4_{HEX} ~ E6_{HEX}

Default Value: 00_{HEX}

BIT	DESCRIPTION
7-0	T_D0C1_C1 [7:0] ~ T_D2C1_C1 [7:0] T_D0C1_C1 : CPU1 Channel1 DIMM0 Temperature T_D1C1_C1 : CPU1 Channel1 DIMM1 Temperature T_D2C1_C1 : CPU1 Channel1 DIMM2 Temperature

EN_C1_C1 – Enable Read CPU1 Channel1 DIMM Temperature Register

Location: Bank 2 Address E7_{HEX}

Default Value: 07_{HEX}

BIT	DESCRIPTION
7-3	Reserved
2	EN_T_DIMM2_CH1_C1 – Enable DTS CPU1 Channel1 DIMM2 temperature monitoring. 0 = Disable 1 = Enable
1	EN_T_DIMM1_CH1_C1 – Enable DTS CPU1 Channel1 DIMM1 temperature monitoring. 0 = Disable 1 = Enable
0	EN_T_DIMM0_CH1_C1 – Enable DTS CPU1 Channel1 DIMM0 temperature monitoring. 0 = Disable 1 = Enable

T_DxC2_C1 – CPU1 Channel2 DIMM0~DIMM2 Temperature Value Register

Location: Bank 2 Address E8_{HEX} ~ EA_{HEX}

Default Value: 00_{HEX}

BIT	DESCRIPTION
7-0	T_D0C2_C1 [7:0] ~ T_D2C2_C1 [7:0] T_D0C2_C1 : CPU1 Channel2 DIMM0 Temperature T_D1C2_C1 : CPU1 Channel2 DIMM1 Temperature T_D2C2_C1 : CPU1 Channel2 DIMM2 Temperature

EN_C2_C1 – Enable Read CPU1 Channel2 DIMM Temperature Register

Location: Bank 2 Address EB_{HEX}

Default Value: 07_{HEX}

BIT	DESCRIPTION
7-3	Reserved
2	EN_T_DIMM2_CH2_C1 – Enable DTS CPU1 Channel2 DIMM2 temperature monitoring. 0 = Disable 1 = Enable
1	EN_T_DIMM1_CH2_C1 – Enable DTS CPU1 Channel2 DIMM1 temperature monitoring. 0 = Disable 1 = Enable
0	EN_T_DIMM0_CH2_C1 – Enable DTS CPU1 Channel2 DIMM0 temperature monitoring. 0 = Disable

BIT	DESCRIPTION
	1 = Enable

T_DxC3_C1 – CPU1 Channel3 DIMM0~DIMM2 Temperature Value Register

Location: Bank 2 Address EC_{HEX} ~ EE_{HEX}

Default Value: 00_{HEX}

BIT	DESCRIPTION
7-0	T_D0C3_C1 [7:0] ~ T_D2C3_C1 [7:0] T_D0C3_C1 : CPU1 Channel3 DIMM0 Temperature T_D1C3_C1 : CPU1 Channel3 DIMM1 Temperature T_D2C3_C1 : CPU1 Channel3 DIMM2 Temperature

EN_C3_C1 – Enable Read CPU1 Channel3 DIMM Temperature Register

Location: Bank 2 Address EF_{HEX}

Default Value: 07_{HEX}

BIT	DESCRIPTION
7-3	Reserved
2	EN_T_DIMM2_CH3_C1 – Enable DTS CPU1 Channel3 DIMM2 temperature monitoring. 0 = Disable 1 = Enable
1	EN_T_DIMM1_CH3_C1 – Enable DTS CPU1 Channel3 DIMM1 temperature monitoring. 0 = Disable 1 = Enable
0	EN_T_DIMM0_CH3_C1 – Enable DTS CPU1 Channel3 DIMM0 temperature monitoring. 0 = Disable 1 = Enable

7.4 Bank 3 REGISTER DETAIL

7.4.1 Temperature to Fan Mapping Relationships (TFMR)

Location:

T1FMR - Bank 3 Address 00_{HEX}

T2FMR - Bank 3 Address 01_{HEX}

T3FMR - Bank 3 Address 02_{HEX}

T4FMR - Bank 3 Address 03_{HEX}

Type: Read / Write

Reset: Power On Reset

RESETIN# with LOCK=0

T1FMR – T4FMR

BIT	7	6	5	4	3	2	1	0
NAME	Reserved				F4SF	F3SF	F2SF	F1SF
DEFAULT	00 _{HEX}							

BIT	DESCRIPTION
7-4	Reserved
3-0	<p>F4SF – F1SF setting involves two purposes. The one is building up the relation between temperature source 1~4 and FANCTL1~4, the other is Fan Control mode assignment.</p> <p>0 = Related FANCTL will operate in manual mode and have no relationship with temperature (Default)</p> <p>1 = Related FANCTL will operate with SmartFan control mode and be linked to relative temperature source 1 ~ 4.</p>

7.4.2 Default Fan Speed at Power-on (DFSP)

Location: **DFSP** - Bank 3 Address 04_{HEX}

Type: Read / Write

Reset: Power On Reset

RESETIN# with LOCK=0

DFSP

BIT	7	6	5	4	3	2	1	0
NAME	DefaultSpeed							
DEFAULT	7F _{HEX}							

BIT	DESCRIPTION
7-0	Specify default fan output duty cycle after 3VDD is available

7.4.3 SmartFan Output Step Up Time (SFOSUT)

Location: **SFOSUT** - Bank 3 Address 05_{HEX}

Type: Read / Write

Reset: Power On Reset
RESETIN# with LOCK=0

SFOSUT

BIT	7	6	5	4	3	2	1	0
NAME	UpTime							
DEFAULT	0A _{HEX}							

BIT	DESCRIPTION
7-0	The update rate for increasing fan output duty cycle. Unit: 0.1sec.

7.4.4 SmartFan Output Step Down Time (SFOSDT)

Location: **SFOSDT** - Bank 3 Address 06_{HEX}

Type: Read / Write

Reset: Power On Reset
RESETIN# with LOCK=0

SFOSDT

BIT	7	6	5	4	3	2	1	0
NAME	DownTime							
DEFAULT	0A _{HEX}							

BIT	DESCRIPTION
7-0	The update rate for decreasing fan output duty cycle. Unit: 0.1sec.

7.4.5 3-Wire Fan Enable and Fan Output Mode Control (FOMC)

Location: **FOMC** - Bank 3 Address 07_{HEX}

Type: Read / Write

Reset: Power On Reset
RESETIN# with LOCK=0

FOMC

BIT	7	6	5	4	3	2	1	0
NAME	3WireFan_En[3:0]				F4OMC	Reserved		
DEFAULT	00 _{HEX}							

BIT	DESCRIPTION
7-4	Enable ultra-low speed DC fan control. It means that DC fan could be driven by very small PWM output frequency or fewer duty cycles.

BIT	DESCRIPTION
	3WireFan_En[3] : Enable FANCTL4 with this function 3WireFan_En[2] : Enable FANCTL3 with this function 3WireFan_En[1] : Enable FANCTL2 with this function 3WireFan_En[0] : Enable FANCTL1 with this function
3	F4OMC : FANCTL4 output mode control. 0 = PWM output (Default) 1 = DC output
2-0	Reserved

7.4.6 Close-Loop Fan control RPM mode and Tolerance (CLFR)

Location: **CLFR** - Bank 3 Address 08_{HEX}

Type: Read / Write

Reset: Power On Reset
 RESETIN# with LOCK=0

CLFR

BIT	7	6	5	4	3	2	1	0
NAME	RPM_En[3:0]				Generic_Tol_RPM			
DEFAULT	02 _{HEX}							

BIT	DESCRIPTION
7-4	Close loop (RPM) or Open loop (Fan Duty) Smart Fan control mode selection RPM_En[3] = 1 => Configure FANCTL4 as Close Loop mode, otherwise, it is open loop mode. RPM_En[2] = 1 => Configure FANCTL3 as Close Loop mode, otherwise, it is open loop mode. RPM_En[1] = 1 => Configure FANCTL2 as Close Loop mode, otherwise, it is open loop mode. RPM_En[0] = 1 => Configure FANCTL1 as Close Loop mode, otherwise, it is open loop mode.
3-0	RPM tracking target tolerance. It could suppress the oscillation phenomenon in target RPM lock period. Generic_Tol_RPM : Tolerance of RPM mode, unit is 50 RPMs. If Enable RHSF - Bank 3 Address 0E _{HEX} , unit is 100 RPM.

7.4.7 Temperature Source Selection (TSS)

Location:

F1TSS - Bank 3 Address 09_{HEX}

F2TSS - Bank 3 Address 0A_{HEX}

F3TSS - Bank 3 Address 0B_{HEX}

F4TSS - Bank 3 Address 0C_{HEX}

Type: Read / Write

Reset: Power On Reset
 RESETIN# with LOCK=0

F1TSS – F4TSS

BIT	7	6	5	4	3	2	1	0
NAME	Reserved		TSS[5:0]					
DEFAULT	00 _{HEX}							

BIT	DESCRIPTION
7-6	Reserved
5-0	TSS: Temperature source selection
	00_0000: VSEN2_HV/TEMP_CH1_HV - Bank 0 Address 42 _{HEX}
	00_0001: VSEN4_HV/TEMP_CH2_HV - Bank 0 Address 46 _{HEX}
	00_0010: VSEN6_HV/TEMP_CH3_HV - Bank 0 Address 4A _{HEX}
	00_0011: VSEN8_HV/TEMP_CH4_HV - Bank 0 Address 4E _{HEX}
	00_0100: LTD_HV -Bank 0 Address 62 _{HEX}
	00_0101: T_CPU1_HV - Bank 0 Address A0 _{HEX}
	00_0110: T_CPU2_HV - Bank 0 Address A2 _{HEX}
	00_0111: T_CPU3_HV - Bank 0 Address A4 _{HEX}
	00_1000: T_CPU4_HV - Bank 0 Address A6 _{HEX}
	00_1001: T_CPU5_HV - Bank 0 Address A8 _{HEX}
	00_1010: T_CPU6_HV - Bank 0 Address AA _{HEX}
	00_1011: T_CPU7_HV - Bank 0 Address AC _{HEX}
	00_1100: PCH_PCH_0 - Bank 0 Address F0 _{HEX}
	00_1101: PCH_PCH_1 - Bank 0 Address F1 _{HEX}
	00_1110: PCH_CPU_I - Bank 0 Address F3 _{HEX}
	00_1111: PCH_MCH - Bank 0 Address F4 _{HEX}
	01_0000: PCH_DIMM0 - Bank 0 Address F5 _{HEX}
	01_0001: PCH_DIMM1 - Bank 0 Address F6 _{HEX}
	01_0010: PCH_DIMM2 - Bank 0 Address F7 _{HEX}
	01_0011: PCH_DIMM3 - Bank 0 Address F8 _{HEX}
	01_0100: VRT_TEMP1_V - Bank 0 Address B8 _{HEX}
	01_0101: VRT_TEMP2_V - Bank 0 Address B9 _{HEX}
	01_0110: VRT_TEMP3_V - Bank 0 Address BA _{HEX}
	01_0111: VRT_TEMP4_V - Bank 0 Address BB _{HEX}
	01_1000: MT_C0_C0 - Bank 2 Address C4 _{HEX}
	01_1001: MT_C1_C0 - Bank 2 Address C5 _{HEX}
	01_1010: MT_C2_C0 - Bank 2 Address C6 _{HEX}
	01_1011: MT_C3_C0 - Bank 2 Address C7 _{HEX}
	01_1100: MT_C0_C1 - Bank 2 Address C8 _{HEX}

BIT	DESCRIPTION
01_1101: MT_C1_C1	- Bank 2 Address C9 _{HEX}
01_1110: MT_C2_C1	- Bank 2 Address CA _{HEX}
01_1111: MT_C3_C1	- Bank 2 Address CB _{HEX}
10_0000: MT_C0	- Bank 2 Address CC _{HEX}
10_0001: MT_C1	- Bank 2 Address CD _{HEX}
10_0010: MT_SYS	- Bank 2 Address CE _{HEX}
10_0011: EXT_VRT_TEMP1_V	- Bank 0 Address BC _{HEX}
10_0100: EXT_VRT_TEMP2_V	- Bank 0 Address BD _{HEX}
10_0101: EXT_VRT_TEMP3_V	- Bank 0 Address BE _{HEX}
10_0110: EXT_VRT_TEMP4_V	- Bank 0 Address BF _{HEX}
10_0111 ~ 11_1111: Reserved	

7.4.8 Power Accumulate Enable (PAE)

Location: **PAE** - Bank 3 Address 0D_{HEX}

Type: Read / Write

Reset: Power On Reset

RESETIN# with LOCK=0

PAE

BIT	7	6	5	4	3	2	1	0
NAME	Reserved				PWR_MD[3:0]			
DEFAULT	00 _{HEX}							

BIT	DESCRIPTION
7-4	Reserved.
3-0	<p>Sensor based fan control mode enabling.</p> <p>PWR_MD[3] = 1 => FANCTL4 supports sensor based fan control. Otherwise, it is driven by other traditional fan control mode.</p> <p>PWR_MD[2] = 1 => FANCTL3 supports sensor based fan control. Otherwise, it is driven by other traditional fan control mode.</p> <p>PWR_MD[1] = 1 => FANCTL2 supports sensor based fan control. Otherwise, it is driven by other traditional fan control mode.</p> <p>PWR_MD[0] = 1 => FANCTL1 supports sensor based fan control. Otherwise, it is driven by other traditional fan control mode.</p>

7.4.9 Close-Loop Fan Control RPM mode for High Speed Fan Register (RHSF)

Location: **RHSF** - Bank 3 Address 0E_{HEX}

Type: Read / Write

Reset: Power On Reset
RESETIN# with LOCK=0

RHSF

BIT	7	6	5	4	3	2	1	0
NAME	SF_TM_U	Reserved			RPM_HS[3:0]			
DEFAULT	00 _{HEX}							

BIT	DESCRIPTION
7	Smart FAN IV PWM values update rate. SF_TM_U = 0 => Update rate is 10 times/sec. SF_TM_U = 1 => Update rate is 20 times/sec.
6-4	Reserved.
3-0	Changing default unit of all RPM setting from 50 RPMs to 100 RPMs. It benefits to control ultra-high RPM fan. RPM_HS[3] = 1 => FANCTL4 supports ultra-high RPM fan control. RPM_HS[2] = 1 => FANCTL3 supports ultra-high RPM fan control. RPM_HS[1] = 1 => FANCTL2 supports ultra-high RPM fan control. RPM_HS[0] = 1 => FANCTL1 supports ultra-high RPM fan control.

7.4.10 PROCHOT Fan Select (PFS)

Location: **PFS** - Bank 3 Address 0F_{HEX}

Type: Read / Write

Reset: Power On Reset
RESETIN# with LOCK=0

PFS

BIT	7	6	5	4	3	2	1	0
NAME	Reserved				PHOT_FAN_SEL[3:0]			
DEFAULT	00 _{HEX}							

BIT	DESCRIPTION
7-4	Reserved.
3-0	Select targeted FANCTL to react to specific thermal alert event. PHOT_FAN_SEL[3] = 1 => FANCTL4 will respond to specific thermal alert event. PHOT_FAN_SEL[2] = 1 => FANCTL3 will respond to specific thermal alert event. PHOT_FAN_SEL[1] = 1 => FANCTL2 will respond to specific thermal alert event. PHOT_FAN_SEL[0] = 1 => FANCTL1 will respond to specific thermal alert event. These settings are available only while asserting PH_CTRL0 defined in Bank 0 Address 23 _{HEX}

7.4.11 Fan Output Value (FOV)

Location:

F10V - Bank 3 Address 10_{HEX}

F20V - Bank 3 Address 11_{HEX}

F30V - Bank 3 Address 12_{HEX}

F40V - Bank 3 Address 13_{HEX}

Type: Read / Write (in Manual Mode)
Read Only (in the Smart Fan mode)

Reset: Power On Reset
RESETIN# with LOCK=0

F10V – F40V

BIT	7	6	5	4	3	2	1	0
NAME	Output Value							
DEFAULT	Depend on <u>DefaultSpeed</u> . 7F _{HEX} .							

BIT	DESCRIPTION
7-0	Output Value involves two meaning. The one is current out fan duty in Smart Fan mode, the other is fixed fan output duty cycle in manual mode. If 3VDD is loss, these registers are set back to zero by hardware.

7.4.12 Fan Output PWM Frequency Prescaler (FOPFP)

Location:

F10PFP - Bank 3 Address 14_{HEX}

F20PFP - Bank 3 Address 15_{HEX}

F30PFP - Bank 3 Address 16_{HEX}

F40PFP - Bank 3 Address 17_{HEX}

Type: Read / Write

Reset: Power On Reset
RESETIN# with LOCK=0

F10PFP – F40PFP

BIT	7	6	5	4	3	2	1	0
NAME	CKSEL	Divisor						
DEFAULT	1	0	0	0	0	1	0	0

BIT	DESCRIPTION
7	CKSEL – Clock source select. CLKIN Frequency CLKSEL 14.318MHz 33MHz 48MHz 0 1.024KHz 1.024KHz 1KHz 1 55.93Kz 130.21KHz 125KHz
6-0	Divisor – Clock frequency Divisor.

The clock source selected by CKSEL will be divided by the divisor and used as a fan PWM output frequency. There are 2 divisors depending on CKSEL.

If CKSEL equals 1, then the output clock is simply equal to 130.21/ (Divisor+1) KHz (@ frequency of CLKIN is 33MHz).

If CKSEL equals 0, the output clock is 1KHz/MappedDivisor. MappedDivisor depends on Divisor[3:0] and is described in the table below.

Divisor[3:0]	Mapped Divisor	Output Frequency	Divisor[3:0]	Mapped Divisor	Output Frequency
0000	1	1024Hz	1000	12	85Hz
0001	2	512Hz	1001	16	64Hz
0010	3	341Hz	1010	32	32Hz
0011	4	256Hz	1011	64	16Hz
0100	5	205Hz	1100	128	8Hz
0101	6	171Hz	1101	256	4Hz
0110	7	146Hz	1110	512	2Hz
0111	8	128Hz	1111	1024	1Hz

7.4.13 Fan Output Nonstop Enable (FONE)

Location: **FONE** - Bank 3 Address 18_{HEX}

Type: Read / Write

Reset: Power On Reset
RESETIN# with LOCK=0

FONE

BIT	7	6	5	4	3	2	1	0
NAME	Reserved				NON_STOP_En[3:0]			
DEFAULT	00 _{HEX}							

BIT	DESCRIPTION
7-4	Reserved.
3-0	Enabling the feature that fan could be stopped with special condition. This feature also requires other setting, including Bank 3 Address 2C _{HEX} , 2D _{HEX} , 2E _{HEX} and 2F _{HEX} in FONV (Fan Output Nonstop Value) NON_STOP_En[3] = 1 => Enable FANCTL4 stop function. NON_STOP_En[2] = 1 => Enable FANCTL3 stop function. NON_STOP_En[1] = 1 => Enable FANCTL2 stop function. NON_STOP_En[0] = 1 => Enable FANCTL1 stop function.

7.4.14 Fan Tachometer Source Selection (FTSS)

Location: **FTSS** - Bank 3 Address 1B_{HEX}

Type: Read / Write

Reset: Power On Reset
RESETIN# with LOCK=0

FTSS

BIT	7	6	5	4	3	2	1	0
NAME	FAN2_SEL				FAN1_SEL			
DEFAULT	00 _{HEX}							

BIT	DESCRIPTION
7-4	F2FTSS: Fan2 Tachometers Source Selection
3-0	F1FTSS: Fan1 Tachometers Source Selection
	0000: Source Select FANIN_1 0001: Source Select FANIN_2 0010: Source Select FANIN_3 0011: Source Select FANIN_4 0100: Source Select FANIN_5 0101: Source Select FANIN_6 0110: Source Select FANIN_7 0111: Source Select FANIN_8 1000: Source Select FANIN_9 1001: Source Select FANIN_10 1010: Source Select FANIN_11 1011: Source Select FANIN_12

7.4.15 Fan Tachometer Source Selection (FTSS)

Location: **FTSS** - Bank 3 Address 1C_{HEX}
 Type: Read / Write
 Reset: Power On Reset
 RESETIN# with LOCK=0

FTSS

BIT	7	6	5	4	3	2	1	0
NAME	FAN4_SEL				FAN3_SEL			
DEFAULT	00 _{HEX}							

BIT	DESCRIPTION
7-4	F4FTSS: Fan4 Tachometers Source Selection
3-0	F3FTSS: Fan3 Tachometers Source Selection
	0000: Source Select FANIN_1 0001: Source Select FANIN_2 0010: Source Select FANIN_3 0011: Source Select FANIN_4 0100: Source Select FANIN_5 0101: Source Select FANIN_6 0110: Source Select FANIN_7 0111: Source Select FANIN_8 1000: Source Select FANIN_9 1001: Source Select FANIN_10 1010: Source Select FANIN_11 1011: Source Select FANIN_12

7.4.16 Critical Temperature to Full Speed all fan (CTFS)

Location:

T1CTFS - Bank 3 Address 20_{HEX}

T2CTFS - Bank 3 Address 21_{HEX}

T3CTFS - Bank 3 Address 22_{HEX}

T4CTFS - Bank 3 Address 23_{HEX}

Type: Read / Write

Reset: Power On Reset
RESETIN# with LOCK=0

T1CTFS – T4CTFS

BIT	7	6	5	4	3	2	1	0
NAME	Critical Temperature							
DEFAULT	5A _{HEX} (90°C)							

BIT	DESCRIPTION
7-0	Critical Temperature setting for each Smart Fan Table. While temperature source exceeds the critical temperature, the relative FANCTL will output full duty cycle. Unit in °C .

7.4.17 Hysteresis of Temperature (HT)

Location:

HT1 - Bank 3 Address 24_{HEX}

HT2 - Bank 3 Address 25_{HEX}

HT3 - Bank 3 Address 26_{HEX}

HT4 - Bank 3 Address 27_{HEX}

Type: Read / Write

Reset: Power On Reset
RESETIN# with LOCK=0

HT1 – HT4

BIT	7	6	5	4	3	2	1	0
NAME	Reserved	Hysteresis of Critical Temperature			Reserved	Hysteresis of Operation Temperature		
DEFAULT		5 _{HEX} (5°C)				3 _{HEX} (3°C)		

BIT	DESCRIPTION
7	Reserved
6-4	Hysteresis of Critical Temperature: Hysteresis for critical temperature on Smart Fan Table 1 ~ 4. The range is 0°C ~7°C
3	Reserved

BIT	DESCRIPTION
2-0	Hysteresis of Operation Temperature: Hysteresis for normal temperature on Smart Fan Table 1 ~ 4. The range is 0°C~7°C

7.4.18 Fan Output Nonstop Value(FONV)

Location:

FONV1 - Bank 3 Address 2C_{HEX}

FONV2 - Bank 3 Address 2D_{HEX}

FONV3 - Bank 3 Address 2E_{HEX}

FONV4 - Bank 3 Address 2F_{HEX}

Type: Read / Write

Reset: Power On Reset

RESETIN# with LOCK=0

FONV1 –FONV4

BIT	7	6	5	4	3	2	1	0
NAME	Fan Output Nonstop Value							
DEFAULT	14 _{HEX}							

BIT	DESCRIPTION
7-0	Fan Output Nonstop Value for each FANCTL output. If enable FONE - Bank 3 Address 18 _{HEX} , the relative FANCTL will output FONV duty cycle.

7.4.19 SMART FAN™ IV Temperature and DC/PWM Table (SFIV)

Location:

Relative Register-at SMART FAN™ IV Control Mode Table

RELATIVE TEMPERAUTRE	NNEMONIC	ADD (Hex)	TYPE
Temp1	T1 – T4	30-33	RW
	PWM1 – PWM4	34-37	RW
Temp2	T1 – T4	38-3B	RW
	PWM1 – PWM4	3C-3F	RW
Temp3	T1 – T4	40-43	RW
	PWM1 – PWM4	44-47	RW
Temp4	T1 – T4	48-4B	RW
	DC/PWM1 – DC/PWM4	4C-4F	RW

Type: Read / Write

Reset: Power On Reset

RESETIN# with LOCK=0

T1 – T4

BIT	7	6	5	4	3	2	1	0
NAME	SMART FAN™ IV Temperature							
DEFAULT	Table T1 = 19 _{HEX} (25°C) Table T2 = 23 _{HEX} (35°C) Table T3 = 2D _{HEX} (45°C) Table T4 = 37 _{HEX} (55°C)							

DC/PWM1 – DC/PWM4

BIT	7	6	5	4	3	2	1	0
NAME	SMART FAN™ IV DC/PWM							
DEFAULT	Table P1 = 8C _{HEX} (140 Duty) Table P2 = AA _{HEX} (170 Duty) Table P3 = C8 _{HEX} (200 Duty) Table P4 = E6 _{HEX} (230 Duty)							

7.4.20 Configure Register of PECI Error (CRPE)

Location: **CRPE** - Bank 3 Address 50_{HEX}

Type: Read / Write

Reset: Power On Reset

RESETIN# with LOCK=0

CRPE

BIT	7	6	5	4	3	2	1	0
NAME	PECI_ERR_FAN4 BIT[1-0]		PECI_ERR_FAN3 BIT[1-0]		PECI_ERR_FAN2 BIT[1-0]		PECI_ERR_FAN1 BIT[1-0]	
	Refer to PECI Error Condition Table for fan output value.							
DEFAULT	00 _{HEX}							

BIT	DESCRIPTION
7-6	FANCTL4 output state selection while PECI served as temperature source happens any abnormal condition.
5-4	FANCTL3 output state selection while PECI served as temperature source happens any abnormal condition.
3-2	FANCTL2 output state selection while PECI served as temperature source happens any abnormal condition.
1-0	FANCTL1 output state selection while PECI served as temperature source happens any abnormal condition.

PECI Error Condition Table:

BIT [1-0]	PECI Error Condition
00 _{BIN}	Fan output value keeps at its current value.
01 _{BIN}	Fan output value will be set to FOMV (Fan Output Min Value when PECI Error).
1X _{BIN}	Fan output value will be set to the full speed value (FFh).

7.4.21 Fan Output Min Value when PECI Error (FOMV)

Location: **FOMV** - Bank 3 Address 51_{HEX}

Type: Read / Write

Reset: Power On Reset
RESETIN# with LOCK=0

FOMV

BIT	7	6	5	4	3	2	1	0
NAME	FanMin							
DEFAULT	80 _{HEX}							

BIT	DESCRIPTION
7-0	FanMin: control the FANCTL1-FANCTL4 fan output min value when PECI error condition is occurred. Also see CRPE (Configure Register of PECI Error)

7.4.22 Mask Register of PECI Error (MRPE)

Location: **MRPE** - Bank 3 Address 52_{HEX}

Type: Read / Write

Reset: Power On Reset
RESETIN# with LOCK=0

MRPE

BIT	7	6	5	4	3	2	1	0
NAME	Reserved				PECI_ERR_MSK[3:0]			
DEFAULT	00 _{HEX}							

BIT	DESCRIPTION
7-4	Reserved.
3-0	PECI_ERR_MSK[3:0]: Mask CRPE setting for FANCTL1-FANCTL4. It means that Fan output value keeps at its current value.

7.4.23 PECI T_DTS Slope Value (PTSV)

Location:

P1TSV - Bank 3 Address 64_{HEX}

P2TSV - Bank 3 Address 65_{HEX}

P3TSV - Bank 3 Address 66_{HEX}

P4TSV - Bank 3 Address 67_{HEX}

Type: Read / Write

Reset: Power On Reset
RESETIN# with LOCK=0

P1TSV – P4TSV

BIT	7	6	5	4	3	2	1	0
NAME	PECI T_DTS_Slope							

DEFAULT	00 _{HEX}
---------	-------------------

BIT	DESCRIPTION								
7-0	<p>This setting is used to define slope of specific CPU's DTS Thermal Profile. DTS Thermal profile need to be configured before enabling sensor based fan control algorithm.</p> <p>PECI T_DTS_Slope:</p> <table border="1"> <tr> <td>Slope[7]=0.5</td> <td>Slope[3]=0.03125</td> </tr> <tr> <td>Slope[6]=0.25</td> <td>Slope[2]=0.015625</td> </tr> <tr> <td>Slope[5]=0.125</td> <td>Slope[1]=0.0078125</td> </tr> <tr> <td>Slope[4]=0.0625</td> <td>Slope[0]=0.00390625</td> </tr> </table> <p>Example: PECI T_DTS_Slope[7:0]=8'h46, mean slope=0.273</p>	Slope[7]=0.5	Slope[3]=0.03125	Slope[6]=0.25	Slope[2]=0.015625	Slope[5]=0.125	Slope[1]=0.0078125	Slope[4]=0.0625	Slope[0]=0.00390625
Slope[7]=0.5	Slope[3]=0.03125								
Slope[6]=0.25	Slope[2]=0.015625								
Slope[5]=0.125	Slope[1]=0.0078125								
Slope[4]=0.0625	Slope[0]=0.00390625								

7.4.24 PECI T_DTS Offset Value (PTOV)

Location:

P1TOV - Bank 3 Address 68_{HEX}

P2TOV - Bank 3 Address 69_{HEX}

P3TOV - Bank 3 Address 6A_{HEX}

P4TOV - Bank 3 Address 6B_{HEX}

Type: Read / Write

Reset: Power On Reset
RESETIN# with LOCK=0

P1TOV – P4TOV

BIT	7	6	5	4	3	2	1	0
NAME	PECI T_DTS Offset							
DEFAULT	00 _{HEX}							

BIT	DESCRIPTION
7-0	This setting is used to define initial offset temperature of specific CPU's DTS Thermal Profile. DTS Thermal profile need to be configured before enabling sensor based fan control algorithm.

7.4.25 Tcontrol_Offset Value for CPU Agent (Address : 30h ~ 33h) (TOV)

Location:

TOV1 - Bank 3 Address 70_{HEX}

TOV2 - Bank 3 Address 71_{HEX}

TOV3 - Bank 3 Address 72_{HEX}

TOV4 - Bank 3 Address 73_{HEX}

Type: Read / Write

Reset: Power On Reset
RESETIN# with LOCK=0

TOV1 – TOV4

BIT	7	6	5	4	3	2	1	0
NAME	Tcontrol_Offset							
DEFAULT	00 _{HEX}							

BIT	DESCRIPTION
7-0	Tcontrol_Offset value is required to adjust the Tcontrol_spec desined in DTS(Sensor) Based Thermal Spec. Tcontrol_Offset: Unit in °C and 2's complement representation.

7.4.26 DTS Delta Tolerance Value (DDTV)

Location:

DDTV1 - Bank 3 Address 80_{HEX}

DDTV2 - Bank 3 Address 81_{HEX}

DDTV3 - Bank 3 Address 82_{HEX}

DDTV4 - Bank 3 Address 83_{HEX}

Type: Read / Write

Reset: Power On Reset
RESETIN# with LOCK=0

DDTV1 – DDTV4

BIT	7	6	5	4	3	2	1	0
NAME	DTS Delta Tolerance Value							
DEFAULT	00 _{HEX}							

BIT	DESCRIPTION
7-0	This setting is used to define Tolerance of DTS (Sensor) Based Fan Control.

7.4.27 DTS Margin Divisor (DMD)

Location: **DMD** - Bank 3 Address 84_{HEX}

Type: Read / Write

Reset: Power On Reset
 RESETIN# with LOCK=0

DMD

BIT	7	6	5	4	3	2	1	0
NAME	DTS_M_DIV[3:0]				Reserved			
DEFAULT	00 _{HEX}							

BIT	DESCRIPTION
7-4	Enabling the DTS Margin Divisor. DTS_M_DIV [3] = 1 => Enable FANCTL4 Margin/2. DTS_M_DIV [2] = 1 => Enable FANCTL3 Margin/2. DTS_M_DIV [1] = 1 => Enable FANCTL2 Margin/2. DTS_M_DIV [0] = 1 => Enable FANCTL1 Margin/2.
3-0	Reserved.

7.5 Bank 4 REGISTER DETAIL

7.5.1 Temperature to Fan Mapping Relationships (TFMR)

Location:

T5FMR - Bank 4 Address 00_{HEX}

T6FMR - Bank 4 Address 01_{HEX}

T7FMR - Bank 4 Address 02_{HEX}

T8FMR - Bank 4 Address 03_{HEX}

T9FMR - Bank 4 Address 04_{HEX}

T10FMR - Bank 4 Address 05_{HEX}

Type: Read / Write

Reset: Power On Reset

RESETIN# with LOCK=0

T5FMR – T10FMR

BIT	7	6	5	4	3	2	1	0
NAME	Reserved				F4SF	F3SF	F2SF	F1SF
DEFAULT	00 _{HEX}							

BIT	DESCRIPTION
7-4	Reserved
3-0	<p>F4SF – F1SF setting involves two purposes. The one is building up the relation between temperature source 5~10 and FANCTL1~4, the other is Fan Control mode assignment.</p> <p>0 = Related FANCTL will operate in manual mode and have no relationship with temperature (Default)</p> <p>1 = Related FANCTL will operate with SmartFan control mode and be linked to relative temperature source 5 ~ 10.</p>

7.5.2 Temperature Source Selection (TSS)

Location:

TSS5 - Bank 4 Address 08_{HEX}

TSS6 - Bank 4 Address 09_{HEX}

TSS7 - Bank 4 Address 0A_{HEX}

TSS8 - Bank 4 Address 0B_{HEX}

TSS9 - Bank 4 Address 0C_{HEX}

TSS10 - Bank 4 Address 0D_{HEX}

Type: Read / Write

Reset: Power On Reset

RESETIN# with LOCK=0

F5TSS – F10TSS

BIT	7	6	5	4	3	2	1	0
NAME	Reserved		TSS[5:0]					
DEFAULT	00 _{HEX}							

BIT	DESCRIPTION
7-6	Reserved.
5-0	TSS: Temperature source selection
	00_0000: VSEN2_HV/TEMP_CH1_HV - Bank 0 Address 42 _{HEX}
	00_0001: VSEN4_HV/TEMP_CH2_HV - Bank 0 Address 46 _{HEX}
	00_0010: VSEN6_HV/TEMP_CH3_HV - Bank 0 Address 4A _{HEX}
	00_0011: VSEN8_HV/TEMP_CH4_HV - Bank 0 Address 4E _{HEX}
	00_0100: LTD_HV -Bank 0 Address 62 _{HEX}
	00_0101: T_CPU1_HV - Bank 0 Address A0 _{HEX}
	00_0110: T_CPU2_HV - Bank 0 Address A2 _{HEX}
	00_0111: T_CPU3_HV - Bank 0 Address A4 _{HEX}
	00_1000: T_CPU4_HV - Bank 0 Address A6 _{HEX}
	00_1001: T_CPU5_HV - Bank 0 Address A8 _{HEX}
	00_1010: T_CPU6_HV - Bank 0 Address AA _{HEX}
	00_1011: T_CPU7_HV - Bank 0 Address AC _{HEX}
	00_1100: PCH_PCH_0 - Bank 0 Address F0 _{HEX}
	00_1101: PCH_PCH_1 - Bank 0 Address F1 _{HEX}
	00_1110: PCH_CPU_I - Bank 0 Address F3 _{HEX}
	00_1111: PCH_MCH - Bank 0 Address F4 _{HEX}
	01_0000: PCH_DIMM0 - Bank 0 Address F5 _{HEX}
	01_0001: PCH_DIMM1 - Bank 0 Address F6 _{HEX}
	01_0010: PCH_DIMM2 - Bank 0 Address F7 _{HEX}
	01_0011: PCH_DIMM3 - Bank 0 Address F8 _{HEX}
	01_0100: VRT_TEMP1_V - Bank 0 Address B8 _{HEX}
	01_0101: VRT_TEMP2_V - Bank 0 Address B9 _{HEX}
	01_0110: VRT_TEMP3_V - Bank 0 Address BA _{HEX}
	01_0111: VRT_TEMP4_V - Bank 0 Address BB _{HEX}
	01_1000: MT_C0_C0 - Bank 2 Address C4 _{HEX}
	01_1001: MT_C1_C0 - Bank 2 Address C5 _{HEX}
	01_1010: MT_C2_C0 - Bank 2 Address C6 _{HEX}
	01_1011: MT_C3_C0 - Bank 2 Address C7 _{HEX}
	01_1100: MT_C0_C1 - Bank 2 Address C8 _{HEX}
	01_1101: MT_C1_C1 - Bank 2 Address C9 _{HEX}
	01_1110: MT_C2_C1 - Bank 2 Address CA _{HEX}
	01_1111: MT_C3_C1 - Bank 2 Address CB _{HEX}
	10_0000: MT_C0 - Bank 2 Address CC _{HEX}
	10_0001: MT_C1 - Bank 2 Address CD _{HEX}

BIT	DESCRIPTION
10_0010: MT_SYS	- Bank 2 Address CE _{HEX}
10_0011: EXT_VRT_TEMP1_V	- Bank 0 Address BC _{HEX}
10_0100: EXT_VRT_TEMP2_V	- Bank 0 Address BD _{HEX}
10_0101: EXT_VRT_TEMP3_V	- Bank 0 Address BE _{HEX}
10_0110: EXT_VRT_TEMP4_V	- Bank 0 Address BF _{HEX}
10_0111 ~ 11_1111: Reserved	

7.5.3 Critical Temperature to Full Speed all fan (CTFS)

Location:

T5CTFS - Bank 4 Address 10_{HEX}

T6CTFS - Bank 4 Address 11_{HEX}

T7CTFS - Bank 4 Address 12_{HEX}

T8CTFS - Bank 4 Address 13_{HEX}

T9CTFS - Bank 4 Address 14_{HEX}

T10CTFS - Bank 4 Address 15_{HEX}

Type: Read / Write

Reset: Power On Reset

RESETIN# with LOCK=0

T5CTFS – T10CTFS

BIT	7	6	5	4	3	2	1	0
NAME	Critical Temperature							
DEFAULT	5A _{HEX} (90°C)							

BIT	DESCRIPTION
7-0	Critical Temperature setting for each Smart Fan Table 5 ~ 10. While temperature source exceeds the critical temperature, the relative FANCTL will output full duty cycle. Unit in °C .

7.5.4 Hysteresis of Temperature (HT)

Location:

- HT5 - Bank 4 Address 20_{HEX}
- HT6 - Bank 4 Address 21_{HEX}
- HT7 - Bank 4 Address 22_{HEX}
- HT8 - Bank 4 Address 23_{HEX}
- HT9 - Bank 4 Address 24_{HEX}
- HT10 - Bank 4 Address 25_{HEX}

Type: Read / Write

Reset: Power On Reset
RESETIN# with LOCK=0

HT5 – HT10

BIT	7	6	5	4	3	2	1	0
NAME	Reserved	Hysteresis of Critical Temperature			Reserved	Hysteresis of Operation Temperature		
DEFAULT	5 _{HEX} (5°C)				3 _{HEX} (3°C)			

BIT	DESCRIPTION
7	Reserved
6-4	Hysteresis of Critical Temperature: Hysteresis for critical temperature on Smart Fan Table 5 ~ 10. The range is 0°C ~7°C
3	Reserved
2-0	Hysteresis of Operation Temperature: Hysteresis for normal temperature on Smart Fan Table 5 ~ 10. The range is 0°C ~7°C

7.5.5 SMART FAN™ IV Temperature and DC/PWM Table (SFIV)

Location:

Relative Register-at SMART FAN™ IV Control Mode Table

RELATIVE TEMPERAUTRE	NNEMONIC	ADD (Hex)	TYPE
Temp5	T1 – T4	30-33	RW
	PWM1 – PWM4	34-37	RW
Temp6	T1 – T4	38-3B	RW
	PWM1 – PWM4	3C-3F	RW
Temp7	T1 – T4	40-43	RW
	PWM1 – PWM4	44-47	RW
Temp8	T1 – T4	48-4B	RW
	DC/PWM1 – DC/PWM4	4C-4F	RW
Temp9	T1 – T4	50-53	RW
	DC/PWM1 – DC/PWM4	54-57	RW

RELATIVE TEMPERAUTRE	NNEMONIC	ADD (Hex)	TYPE
Temp10	T1 – T4	58-5B	RW
	DC/PWM1 – DC/PWM4	5C-5F	RW

Type: Read / Write
 Reset: Power On Reset
 RESETIN# with LOCK=0

T1 – T4

BIT	7	6	5	4	3	2	1	0
NAME	SMART FAN™ IV Temperature							
DEFAULT	Table T1 = 19 _{HEX} (25°C) Table T2 = 23 _{HEX} (35°C) Table T3 = 2D _{HEX} (45°C) Table T4 = 37 _{HEX} (55°C)							

DC/PWM1 – DC/PWM4

BIT	7	6	5	4	3	2	1	0
NAME	SMART FAN™ IV DC/PWM							
DEFAULT	Table P1 = 8C _{HEX} (140 Duty) Table P2 = AA _{HEX} (170 Duty) Table P3 = C8 _{HEX} (200 Duty) Table P4 = E6 _{HEX} (230 Duty)							

8. ELECTRICAL CHARACTERISTICS

8.1 Absolute Maximum Ratings

PARAMETER		RATING	UNIT
Power Supply Voltage	3VSB,3VDD,VBAT	3.3 ± 5%	V
	VTT	2.048	
Input Voltage		-0.3 to +3.6	V
Operating Temperature		-40 to +120 ^{*1}	°C
Storage Temperature		-55 to +150	°C

*1 Guaranteed by design from -40~120 degree C, 100% tested at 85 degree C.

8.2 DC Specification

(Ta = 0° C to 70° C, 3VDD= 3.3V ± 5%, 3VSB =3.3V ± 5%, GND = 0V)

PARAMETER	SYM.	MIN.	TYP.	MAX.	UNIT	CONDITIONS
OD – Open-drain output pin with source-sink capability of 12 mA						
Output Low Voltage	V _{OL}			0.4	V	I _{OL} = 12 mA
TSI – For AMD™ TSI design						
Input Low Voltage	V _{IL}		0.6		V	
Input High Voltage	V _{IH}		1		V	
Output Low Voltage	V _{OL}			0.285	V	
PECI – Bi-direction pin for INTEL™ PECI						
Input Low Voltage	V _{IL}	0.275V _{tt}		0.5V _{tt}	V	
Input High Voltage	V _{IH}	0.55V _{tt}		0.725V _{tt}	V	
Output Low Voltage	V _{OL}			0.25V _{tt}	V	
Output High Voltage	V _{OH}	0.75V _{tt}			V	
GTL –For PROCHOT, THERMTRIP						
Input Low Voltage	V _{IL}			0.4	V	
Input High Voltage	V _{IH}	0.8			V	

PARAMETER	SYM.	MIN.	TYP.	MAX.	UNIT	CONDITIONS
Output Low Voltage	V_{OL}			0.2	V	
I - TTL level Schmitt-triggered input pin						
Input Low Voltage	V_{IL}			0.8	V	$3V_{SB} = 3.3V$
Input High Voltage	V_{IH}	2.0			V	$3V_{SB} = 3.3V$
Input High Leakage	I_{LIH}			+10	μA	$V_{IN} = 3.3V$
Input Low Leakage	I_{LIL}			-10	μA	$V_{IN} = 0V$
AIN - Analog input pin						
Input High Leakage	I_{LIH}			+1	μA	$V_{IN} = 3.3V$
Input Low Leakage	I_{LIL}			-1	μA	$V_{IN} = 0V$
AIN – VSEN17 , VSEN18 , VSEN19						
Input High Leakage	I_{LIH}			+36	μA	$V_{IN} = 3.3V$
Input Low Leakage	I_{LIL}			-10	μA	$V_{IN} = 0V$

8.3 AC Specification

SMBus Interface

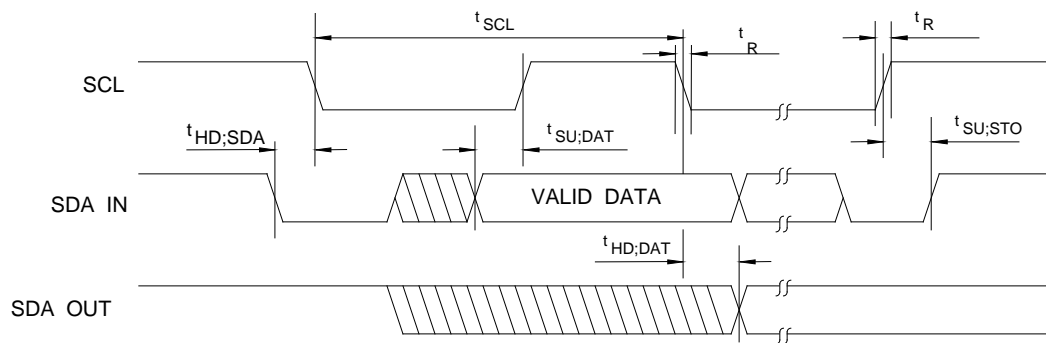

Serial Bus Timing Diagram

PARAMETER	SYMBOL	MIN.	MAX.	UNIT
SCL clock period	t_{SCL}	10		μS
Start condition hold time	$t_{HD;SDA}$	4.0		μS
Stop condition setup-up time	$t_{SU;STO}$	4.0		μS

DATA to SCL setup time	$t_{SU:DAT}$	150		nS
DATA to SCL hold time	$t_{HD:DAT}$	270		nS
SCL and SDA rise time	t_R		1.0	uS
SCL and SDA fall time	t_F		300	nS

Clock Input Timing

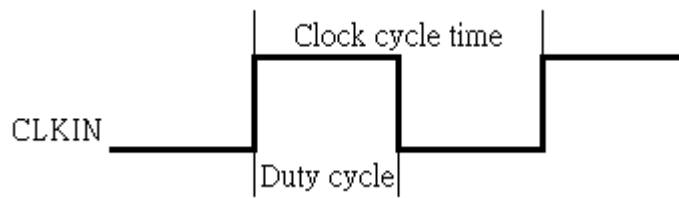

DESCRIPTION	CLKIN		
	MIN	TYP	MAX
Clock cycle time	$(1/CLKIN) \times 0.97$	$1/CLKIN$	$(1/CLKIN) \times 1.03$
Duty cycle	45%		55%

9. ORDER INFORMATION

PART NO.	PACKAGE	REMARKS
NCT7904D	48 LQFP (Halogen free)	

10. TOP MARKING SPECIFICATIONS



1st line: Nuvoton logo

2nd line: part number: **NCT7904D**

3rd line: wafer production series lot number: **28201234-01**

4th line: tracking code: **138GBBA**

138: packages made in '11, week 38

G: assembly house ID

B: Chip Version

BA: Nuvoton internal use

11. PACKAGE DRAWING AND DIMENSIONS

48-pin LQFP (7 mm X7 mm X1.4mm)

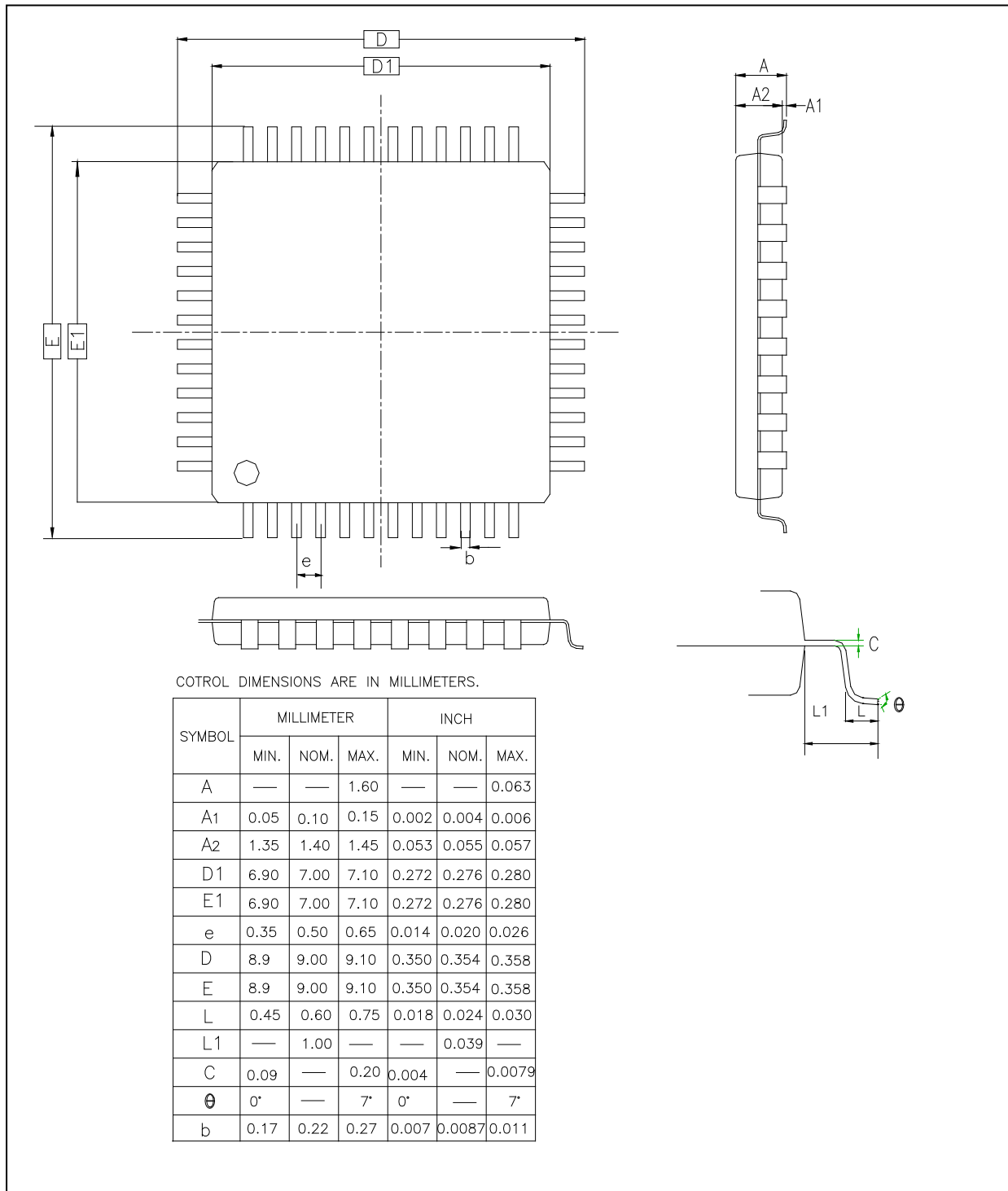

12. REVISION HISTORY

VERSION	DATE	PAGE	DESCRIPTION
0.2	08/17/2010		Preliminary Released.
0.3	10/12/2010	ALL	Fixed the typos.
0.4	02/25/2011	ALL	Updated for new A2 version sample.
0.8	05/04/2011	ALL	Updated Top Marketing & Part No.
0.9	08/08/2011	ALL	Update for new A3 version sample.
0.91	09/21/2011		The content is the same as v0.9. Just update the version to v0.91 for new A4 version sample.
0.95	11/15/2011	29, 31, 32, 39, 40, 43, 114, 127, 134	1. Update PCH thermal data description (section 6.11.2) 2. Update Device ID information 3. Update LOCK description 4. Update Bank0 Addr[2Eh] Mode Control Register description. 5. Change Temperature Source Selection Table configuration of 00_1100 : from Bank0 Address AEh to F0h 6. Update Order Information (Item 1, 2, 5 are updated for rev.B chip)
1.0	1/5/2012	ALL	Public Released. All versions before 1.0 are preliminary versions
1.1	5/31/2012	11,93	1. Fixed the typo. 2. Added External Read Control Register description.
1.2	7/20/2012	114	1.Updated Fan Output PWM Frequency Pre-scalar register.
1.3	2/4/2013	87,88	1. Fixed typo. 2. Updated TSI register descriptions.
1.41	4/11/2013	10,14,15,18,12 9	1.Modified descriptions for VSEN17,18,19. 2.Fixed typo of VSEN17,18,19 formula. 3.Added DC specification for VSEN17,18,19.
1.42	4/29/2013	27,128	1.Added power ramp request on EEPROM self-initialization function. 2.Modified Absolute Maximum Ratings.
1.43	6/24/2013	13,16	Added recommendations for unused pin.
1.44	2/10/2014	80	Updated description of PECE Power Averaging Configure Register Bit[5].
1.45	07/25/2017	10	Update the operating temperature range

Important Notice

Nuvoton Products are neither intended nor warranted for usage in systems or equipment, any malfunction or failure of which may cause loss of human life, bodily injury or severe property damage. Such applications are deemed, "Insecure Usage".

Insecure usage includes, but is not limited to: equipment for surgical implementation, atomic energy control instruments, airplane or spaceship instruments, the control or operation of dynamic, brake or safety systems designed for vehicular use, traffic signal instruments, all types of safety devices, and other applications intended to support or sustain life.

All Insecure Usage shall be made at customer's risk, and in the event that third parties lay claims to Nuvoton as a result of customer's Insecure Usage, customer shall indemnify the damages and liabilities thus incurred by Nuvoton.

Please note that all data and specifications are subject to change without notice.
All the trademarks of products and companies mentioned in this datasheet belong to their respective owners.