

Major Ratings and Characteristics

Characteristics	189NQ...	Units
$I_{F(AV)}$ Rectangular waveform	180	A
V_{RRM} range	135 to 150	V
I_{FSM} @ $t_p = 5 \mu s$ sine	15000	A
V_F @ 180Apk, $T_J = 125^\circ C$	0.74	V
T_J range	-55 to 175	$^\circ C$

Description/Features

The 189NQ high current Schottky rectifier module series has been optimized for low reverse leakage at high temperature. The proprietary barrier technology allows for reliable operation up to 175° C junction temperature. Typical applications are in switching power supplies, converters, free-wheeling diodes, and reverse battery protection.

- 175° C T_J operation
- Unique high power, Half-Pak module
- Replaces three parallel DO-5's
- Easier to mount and lower profile than DO-5's
- High purity, high temperature epoxy encapsulation for enhanced mechanical strength and moisture resistance
- Low forward voltage drop
- High frequency operation
- Guard ring for enhanced ruggedness and long term reliability

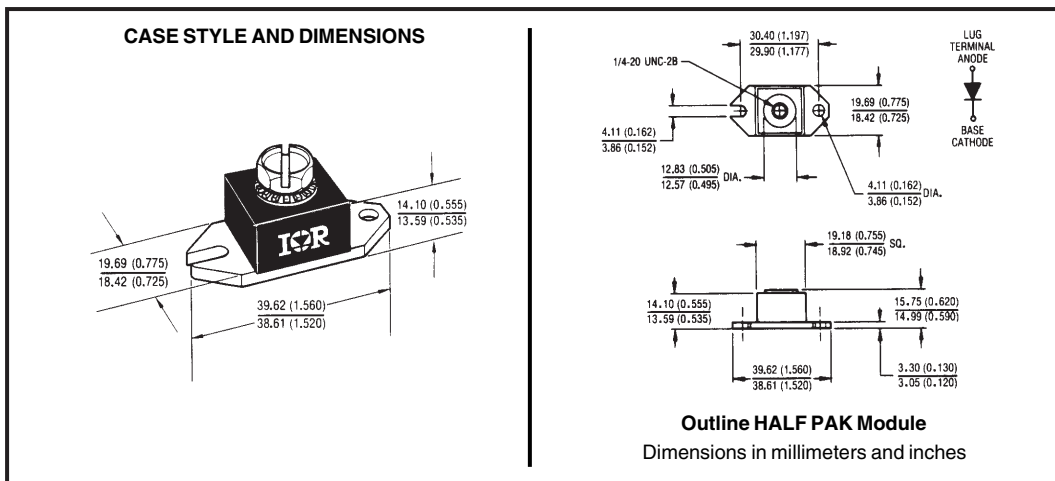

Voltage Ratings

Part number	189NQ135	189NQ150
V_R Max. DC Reverse Voltage (V)	135	150
V_{RWM} Max. Working Peak Reverse Voltage (V)		

Absolute Maximum Ratings

Parameters	189NQ	Units	Conditions
$I_{F(AV)}$ Max. Average Forward Current * See Fig. 5	180	A	50% duty cycle @ $T_C = 110^\circ\text{C}$, rectangular wave form
I_{FSM} Max. Peak One Cycle Non-Repetitive Surge Current * See Fig. 7	15000	A	5 μs Sine or 3 μs Rect. pulse
	1770		10ms Sine or 6ms Rect. pulse
E_{AS} Non-Repetitive Avalanche Energy	15	mJ	$T_J = 25^\circ\text{C}$, $I_{AS} = 1$ Amps, $L = 30$ mH
I_{AR} Repetitive Avalanche Current	1	A	Current decaying linearly to zero in 1 μsec Frequency limited by T_J max. $V_A = 1.5 \times V_R$ typical

Electrical Specifications

Parameters	189NQ	Units	Conditions
V_{FM} Max. Forward Voltage Drop (1) * See Fig. 1	1.07	V	@ 180A
	1.27	V	@ 360A
	0.74	V	@ 180A
	0.86	V	@ 360A
I_{RM} Max. Reverse Leakage Current (1) * See Fig. 2	4.5	mA	$T_J = 25^\circ\text{C}$
	65	mA	$T_J = 125^\circ\text{C}$
C_T Max. Junction Capacitance	4500	pF	$V_R = 5V_{DC}$, (test signal range 100Khz to 1Mhz) 25°C
L_S Typical Series Inductance	6.0	nH	From top of terminal hole to mounting plane
dv/dt Max. Voltage Rate of Change (Rated V_R)	10,000	V/ μs	

(1) Pulse Width < 300 μs , Duty Cycle < 2%

Thermal-Mechanical Specifications

Parameters	189NQ	Units	Conditions
T_J Max. Junction Temperature Range	-55 to 175	$^\circ\text{C}$	
T_{stg} Max. Storage Temperature Range	-55 to 175	$^\circ\text{C}$	
R_{thJC} Max. Thermal Resistance Junction to Case	0.30	$^\circ\text{C}/\text{W}$	DC operation * See Fig. 4
R_{thCS} Typical Thermal Resistance, Case to Heatsink	0.15	$^\circ\text{C}/\text{W}$	Mounting surface, smooth and greased
wt Approximate Weight	25.6(0.9)	g(oz.)	
T Mounting Torque Terminal Torque	Min.	40(35)	Non-lubricated threads
	Max.	58(50)	
	Min.	58(50)	
	Max.	86(75)	
Case Style	HALF PAK Module		

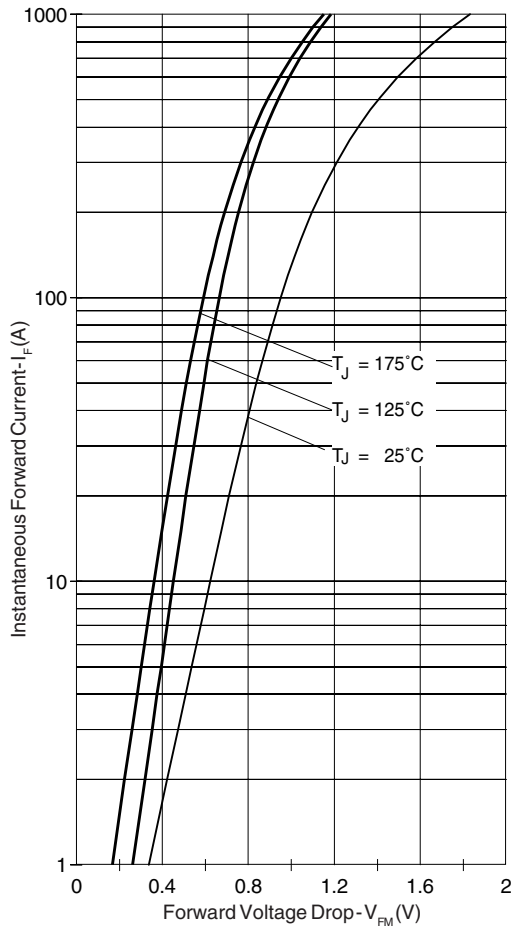

Fig. 1 - Max. Forward Voltage Drop Characteristics

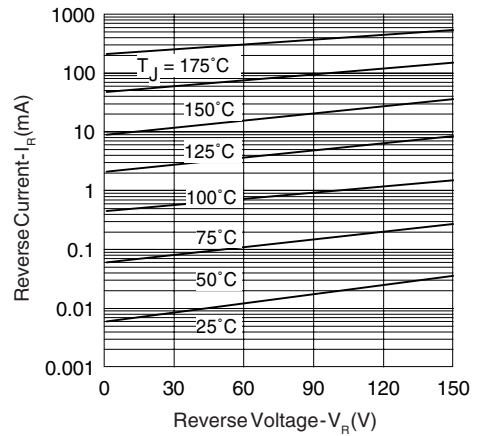

Fig. 2 - Typical Values Of Reverse Current Vs. Reverse Voltage

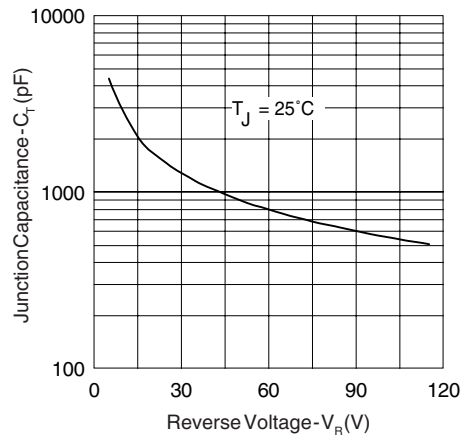

Fig. 3 - Typical Junction Capacitance Vs. Reverse Voltage

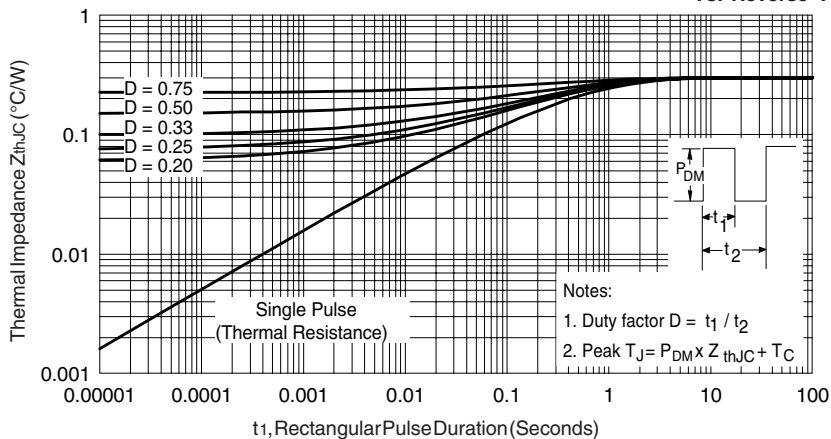

Fig. 4 - Max. Thermal Impedance Z_{thJC} Characteristics

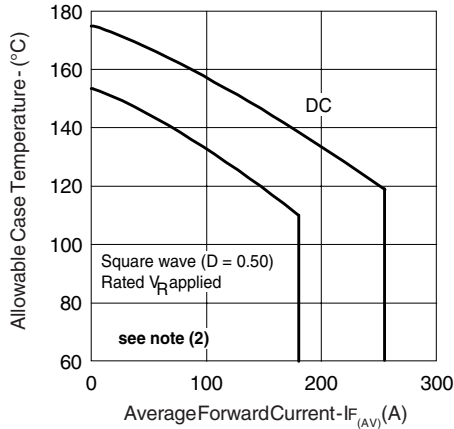

Fig. 5 - Max. Allowable Case Temperature Vs. Average Forward Current

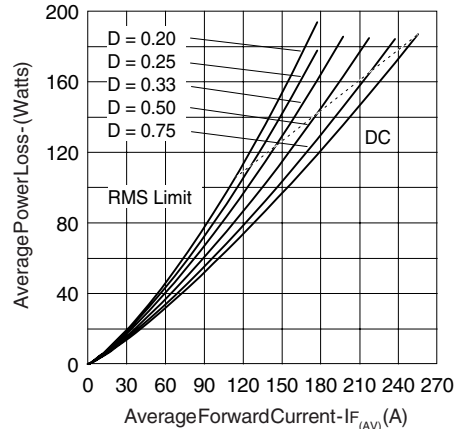

Fig. 6 - Forward Power Loss Characteristics

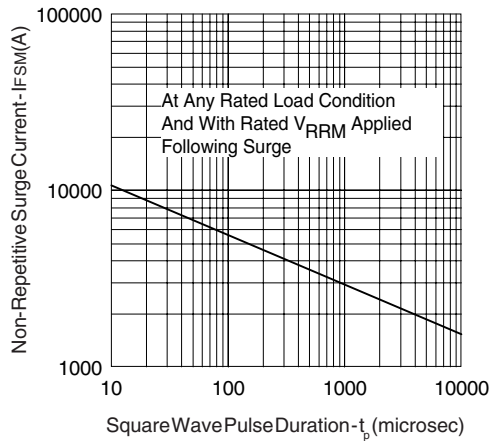

Fig. 7 - Max. Non-Repetitive Surge Current

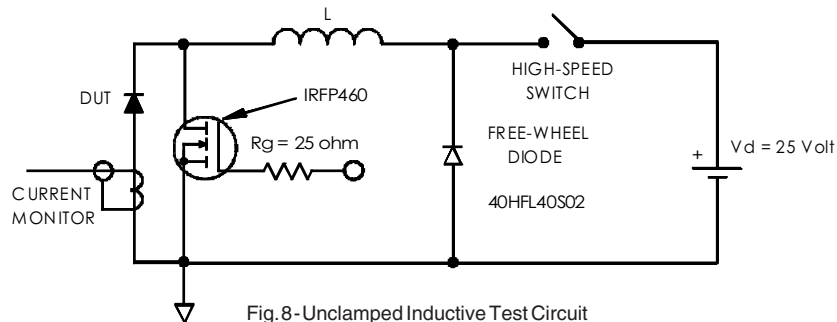

Fig. 8 - Unclamped Inductive Test Circuit

(2) Formula used: $T_C = T_J - (P_d + P_{d_{REV}}) \times R_{thJC}$;

$P_d = \text{Forward Power Loss} = I_{F(AV)} \times V_{FM} @ (I_{F(AV)} / D)$ (see Fig. 6);

$P_{d_{REV}} = \text{Inverse Power Loss} = V_{R1} \times I_R (1 - D)$; $I_R @ V_{R1} = \text{rated } V_R$

