

HSMP-386Z

General Purpose RF PIN Diodes In Surface Mount SOD-323 Package



Data Sheet

Description/Application

Avago Technologies's HSMP-386Z is a General Purpose PIN Diode housed in a low cost surface mount SOD-323 package. This package offers customers who already use the PIN Diode in SOT-23 and SOT-323 packages, a logical transition to a smaller package outline to accommodate end product design with limited board space.

The HSMP-386Z is designed for two classes of applications. The first is attenuator where current consumption is the most important design consideration. The second application is switches where low capacitance is the driving issue for the designer.

A SPICE model is not available for PIN diodes as SPICE does not provide for a key PIN diode characteristic -- carrier lifetime.

Features

- 2 Leads Surface Mount Package
- Switching
 - Low Distortion Switching
 - Low Capacitance
- Attenuating
 - Low Current Attenuating for Less Power Consumption
- MSL 1 & Lead Free
- Tape and Reel Options Available
- Low Failure in Time (FIT) Rate

Package Marking and Pin Connections

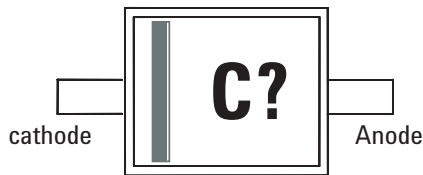

Note:

Package marking provides orientation and identification

"C" = Device Code

"?" = Month code indicates the month of manufacture

Table 1. Absolute Maximum Ratings [1] at Tc = +25°C

Symbol	Parameter	Unit	Max Rating
I_f	Forward Current (1 μ s Pulse)	Amp	1
P_{IV}	Peak Inverse Voltage	V	100
T_j	Junction Temperature	$^{\circ}$ C	150
T_{stg}	Storage Temperature	$^{\circ}$ C	-60 to 150
θ_{jb}	Thermal Resistance ^[2]	$^{\circ}$ C/W	135

Notes:

1. Operation in excess of any one of these conditions may result in permanent damage to the device.
2. Thermal Resistance is measured from junction to board using IR method.

Table 2. Electrical Specifications at Tc = +25°C

	Minimum Breakdown Voltage V_{BR} (V)	Typical Total Resistance R_S (Ohm)	Typical Total Capacitance C_T (pF)
	50	3.0/1.5*	0.20
Test Conditions	$V_R = V_{BR}$ Measure $I_R \leq 10\mu A$	$I_f = 10mA/100mA^*$ $f = 100$ MHz	$V_R = 50V$ $f = 1MHz$

Table 3. Typical Parameters at Tc = +25°C

	Series Resistance R_S (Ohm)	Carrier Lifetime τ (ns)	Reverse Recovery Time T_{rr} (ns)	Total Capacitance C_T (pF)
	22	500	80	0.20
Test Conditions	$I_f = 1$ mA $f = 100$ MHz	$I_f = 50mA$ $I_R = 250mA$	$V_R = 10V$ $I_f = 20mA$ 90% Recovery	$V_R = 50V$ $f = 1MHz$

Typical Performance Curves at $T_c = +25^\circ\text{C}$

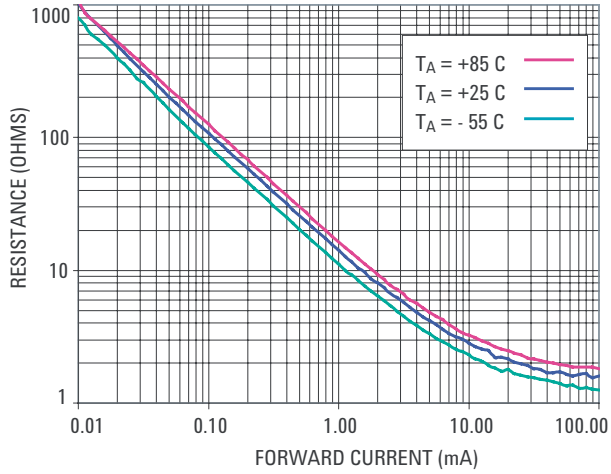

Figure 1. RF Resistance vs. Forward Bias Current

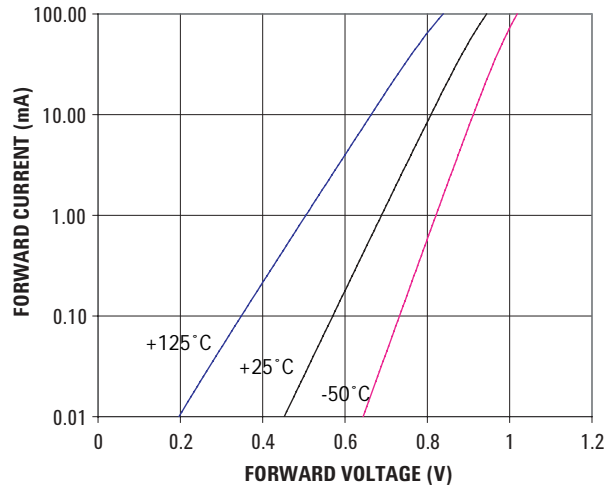

Figure 2. Forward Current vs. Forward Voltage

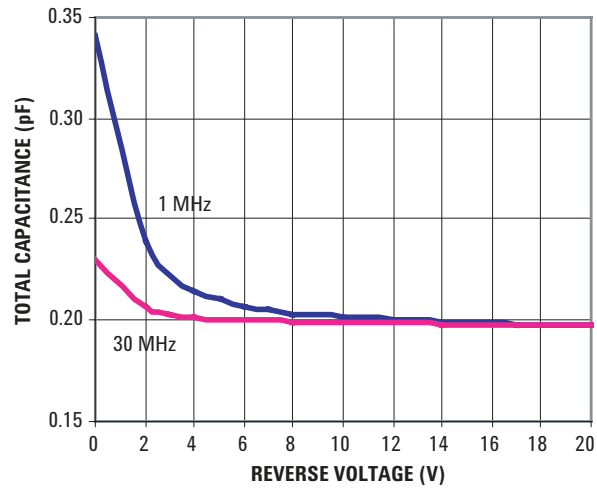

Figure 3. RF Capacitance vs. Reverse Bias

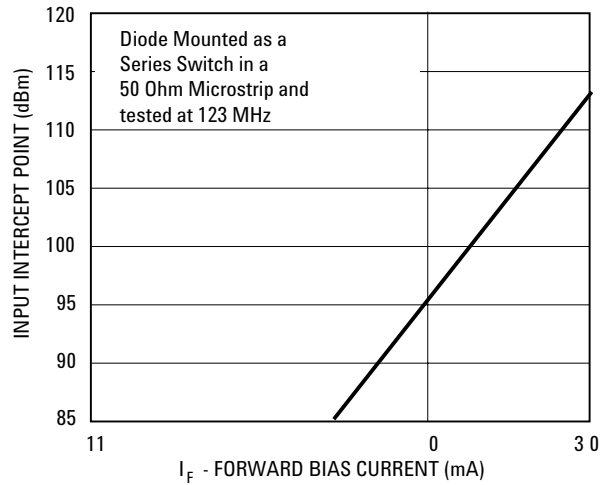

Figure 4. 2nd Harmonic Input Intercept Point vs. Diode RF Resistance

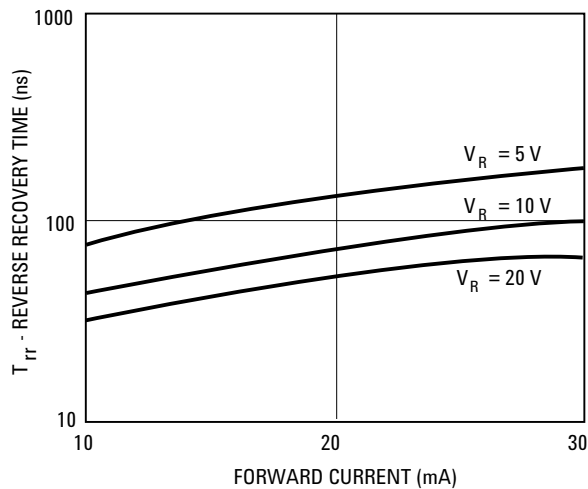
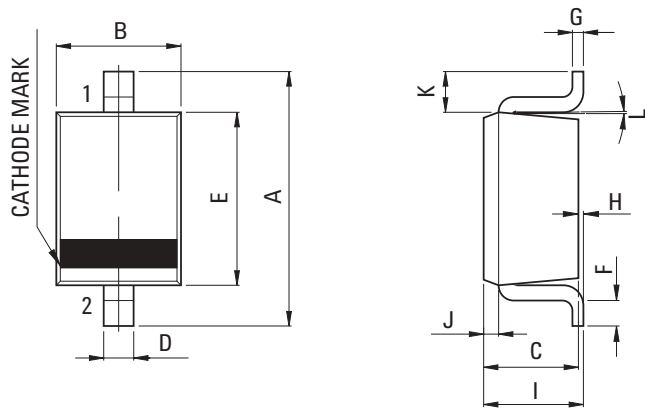
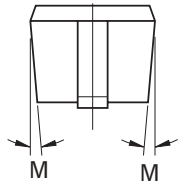
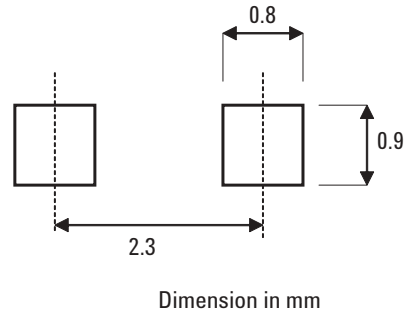

Figure 5. Typical Reverse Recovery Time vs. Reverse Voltage

Package Outline and Dimension



PCB Footprint



DIM	MILLIMETERS
A	2.50 ±0.2
B	1.25 ±0.05
C	0.90 ±0.05
D	0.30+0.06/-0.04
E	1.70 ±0.05
F	MIN 0.17
G	0.126 ±0.03
H	0~0.1
I	1.0 MAX
J	0.15 ±0.05
K	0.4
L	2°+4/-2
M4	~6°

Device Orientation

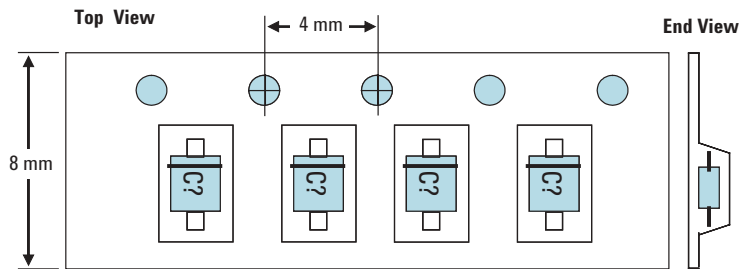
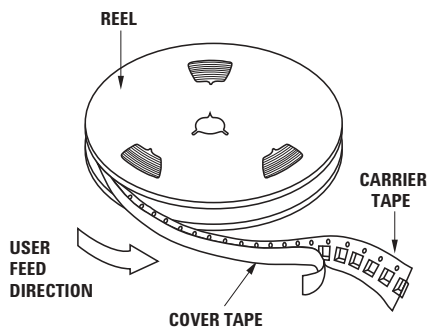

Note: "C" represents package marking code
 "?" represents date code

Tape Dimensions

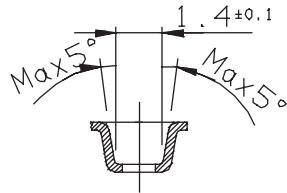
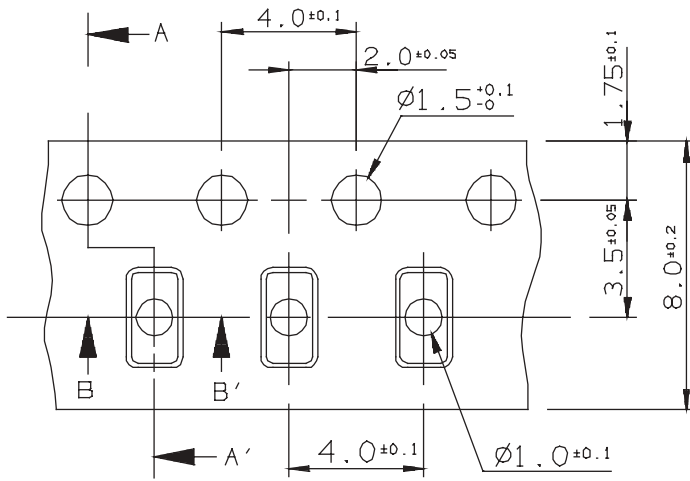

B - B' SECTION

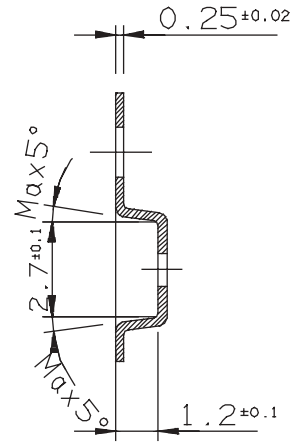

A - A' SECTION

Specification < Unit: mm >

A. hole pitch : 50 Pitch Tolerance : 200 ± 0.3

Part Number Ordering Information

Part number	No. of Units	Container
HSMP-386Z-BLKG	100	Anti-static bag
HSMP-386Z-TR1G	3000	7" reel

For product information and a complete list of distributors, please go to our web site: www.avagotech.com

Avago, Avago Technologies, and the A logo are trademarks of Avago Technologies, Pte. in the United States and other countries. Data subject to change. Copyright © 2006 Avago Technologies Pte. All rights reserved.
5989-4660EN - January 19, 2006

Avago
TECHNOLOGIES