

PI3PD22920/PI3PD22920B

Ultra Small, Low-Input Voltage, Low RON Load Switch

Features

- Integrated Load Switch
- Input Voltage: 0.75-V to 3.6-V
- Intergrated Pass-FET $r_{DS(ON)}=2m\Omega$ (typ) at 3.6-V
- Ultra-Low ON Resistance
 - $r_{ON} = 5.3m\Omega$ at $V_{IN} = 3.6V$
 - $r_{ON} = 5.4m\Omega$ at $V_{IN} = 2.5V$
 - $r_{ON} = 5.5m\Omega$ at $V_{IN} = 1.8V$
 - $r_{ON} = 5.8m\Omega$ at $V_{IN} = 1.2V$
 - $r_{ON} = 6.1m\Omega$ at $V_{IN} = 1.05V$
 - $r_{ON} = 7.3m\Omega$ at $V_{IN} = 0.75V$
- Ultra Small CSP-8 package
0.9 mm x 1.9 mm, 0.5-mm Pitch
- 4-A Maximum Continuous Switch Current
- Shutdown Current 5.5- μ A max
- Low Threshold Control Input
- Controlled Slew Rate to Avoid Inrush Currents
- Quick Output Discharge Transistor
- ESD Performance Tested Per JESD 22
 - 8000-V Human-Body Model (A114-B, Class II)
 - 1000-V Charged-Device Model (C101)
- Totally Lead-Free & Fully RoHS Compliant (Notes 1 & 2)
- Halogen and Antimony Free. “Green” Device (Note 3)

Description

The PI3PD22920/PI3PD22920B is a small, ultra-low r_{ON} load switch with controlled turn on. The device contains a N-channel MOSFET that can operate over an input voltage range of 0.75 V to 3.6 V and switch currents up to 4-A. An integrated charge pump biases the

NMOS switch in order to achieve a minimum switch ON resistance (r_{ON}). The switch is controlled by an on/off input (ON), which is capable of interfacing directly with low-voltage control signals.

The PI3PD22920/PI3PD22920B has a 1250 Ω on-chip load resistor for quick output discharge when the switch is turned off.

The PI3D22920/PI3PD22920B has an internally controlled rise time in order to reduce inrush current. The PI3D22920/PI3PD22920B features a rise time of 880 μ s at 3.6V.

The PI3D22920/PI3PD22920B is available in an ultra-small, space-saving 8-pin CSP package and is characterized for operation over the free-air temperature range of $-40^{\circ}C$ to $85^{\circ}C$.

Applications

- Notebook / Netbook Computer
- Tablet PC
- PDAs / Smartphones
- GPS Navigation Devices
- MP3 Players

Pin Configuration (Bottom View)

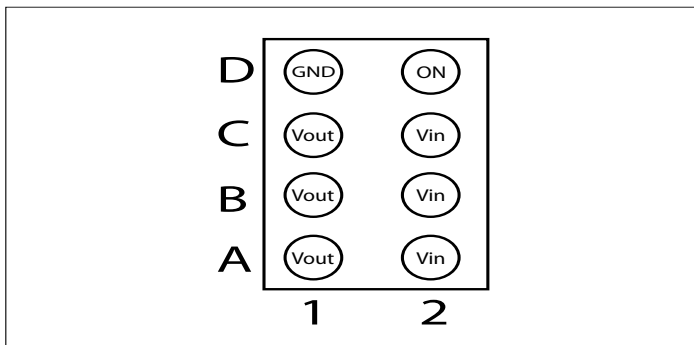

Notes:

1. No purposely added lead. Fully EU Directive 2002/95/EC (RoHS), 2011/65/EU (RoHS 2) & 2015/863/EU (RoHS 3) compliant.
2. See <https://www.diodes.com/quality/lead-free/> for more information about Diodes Incorporated’s definitions of Halogen- and Antimony-free, “Green” and Lead-free.
3. Halogen- and Antimony-free “Green” products are defined as those which contain <900ppm bromine, <900ppm chlorine (<1500ppm total Br + Cl) and <1000ppm antimony compounds.

Functional Block Diagram

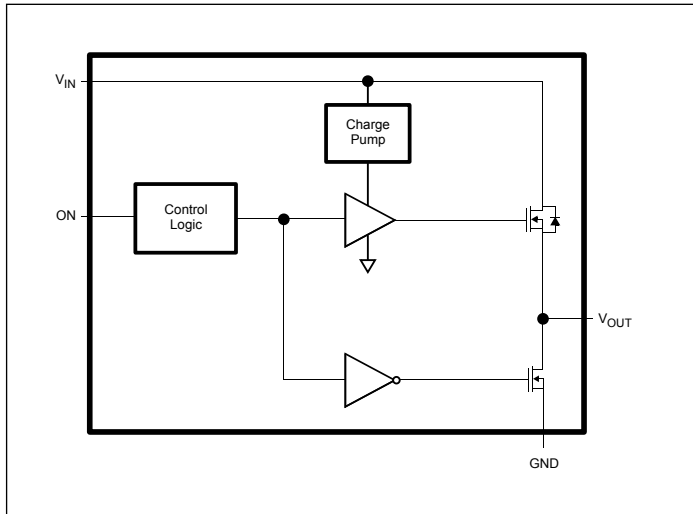

Function Table

ON (Control Input)	V_{IN} to V_{OUT}	V_{OUT} to GND
L	OFF	ON
H	ON	OFF

Pin Description

Terminal		Description
Ball No.	Name	
D1	GND	Ground
D2	ON	Switch Control Input. Active high, do not leave floating.
A1, B1,C1	V_{OUT}	Switch Output
A2, B2,C2	V_{IN}	Switch Input. Bypass this input with a ceramic capacitor to ground.

Absolute Maximum Ratings

V_{IN} , Input voltage range.....	-0.3V to 4V
V_{OUT} , Output voltage range.....	$V_{IN}+0.3V$
V_{ON} , Input voltage range.....	-0.3V to 4V
I_{MAX} , Maximum continuous switch current.....	4A
I_{PLS} , Maximum pulsed current (300- μ s pulse, 2% duty cycle).....	6A
T_A , Operating free-air temperature range.....	-40°C to 85°C
T_J , Maximum junction temperature.....	125°C
T_{STG} , Storage temperature range.....	-65°C to 150°C
T_{LEAD} , Maximum lead temperature(10-s soldering time).....	300°C
ESD, Electrostatic discharge protection , Charged Device Model(CDM).....	1000V
Human-Body Model(HBM).....	8000V

Note:

Stresses beyond those listed under absolute maximum ratings may cause permanent damage to the device. These are stress ratings only, and functional operation of the device at these or any other conditions beyond those indicated under Recommended Operating Conditions is not implied. Exposure to absolute-maximum-rated conditions for extended periods may affect device reliability.

Recommended Operating Conditions

Symbol	Parameter	Min.	Max.	Unit	
V_{IN}	Input voltage range	0.75	3.6	V	
V_{OUT}	Output voltage range		V_{IN}	V	
V_{IH}	High-level input voltage range, ON	$V_{IN} = 2.5\text{ V to }3.6\text{ V}$	1.2	3.6	V
		$V_{IN} = 0.75\text{ V to }2.5\text{ V}$	0.9	3.6	V
V_{IL}	Low-level input voltage range, ON	$V_{IN} = 2.5\text{ V to }3.6\text{ V}$		0.6	V
		$V_{IN} = 0.75\text{ V to }2.49\text{ V}$		0.4	V
C_{IN}	Input capacitor	1		μ F	

DC Electrical Characteristics

Unless otherwise specified, $V_{IN} = 0.75V$ to $3.6V$

Symbol	Parameter	Conditions	T_A^1	Min.	Typ.	Max.	Unit	
Power Switch								
PI3PD22920								
I_{IN}	Quiescent current	$I_{OUT} = 0, V_{IN} = V_{ON}$	Full	-	$V_{IN} = 3.6V$	68	160	μ A
					$V_{IN} = 2.5V$	40	70	
					$V_{IN} = 1.8V$	25	350	
					$V_{IN} = 1.2V$	103	200	
					$V_{IN} = 1.05V$	78	110	
					$V_{IN} = 0.75V$	37	70	
PI3PD22920B								
I_{IN}	Quiescent current	$I_{OUT} = 0, V_{IN} = V_{ON}$	Full	-	$V_{IN} = 3.6V$	35	80	μ A
					$V_{IN} = 2.5V$	25	65	
					$V_{IN} = 1.8V$	20	180	
					$V_{IN} = 1.2V$	50	120	
					$V_{IN} = 1.05V$	40	78	
					$V_{IN} = 0.75V$	22	65	

Symbol	Parameter	Conditions	T _A ¹	Min.	Typ.	Max.	Unit
I _{IN(LEAKAGE)}	OFF-state supply current	V _{ON} = GND, V _{OUT} = 0	Full			5.5	μA
R _{ON}	ON-state resistance	I _{OUT} = -200 mA	25°C	Full		5.3	8.8
						V _{IN} = 3.6V	9.8
			25°C	Full		5.4	8.9
						V _{IN} = 2.5V	9.9
			25°C	Full		5.5	9.1
						V _{IN} = 1.8V	10.1
			25°C	Full		5.8	9.4
						V _{IN} = 1.2V	10.4
25°C	Full		6.1	9.7			
			V _{IN} = 1.05V	10.8			
25°C	Full		7.3	11.0			
			V _{IN} = 0.75V	12.4			
r _{PD}	Output pulldown resistance ²	V _{IN} = 3.3 V, V _{ON} = 0, I _{OUT} = 3 mA	Full		1250	1500	Ω
I _{ON}	ON input leakage current	V _{ON} = 0.75V to 3.6 V or GND	Full			0.1	μA

Note:

1. Typical values are at V_{IN} = 3.3 V and T_A = 25°C.
2. See Output Pulldown in Application Information.

Switching Characteristics

Symbol	Parameter	Conditions			Min.	Typ.	Max.	Units
V_{IN} = 3.6V, T_A = 25°C (Unless otherwise specified)								
t _{ON}	Turn-ON time	R _L = 10Ω	C _L = 0.1μF	V _{IN} = 3.6V		970		μs
t _{OFF}	Turn-OFF time					3		μs
t _r	V _{OUT} rise time					880		μs
t _f	V _{OUT} fall time					2		μs
V_{IN} = 0.9V, T_A = 25°C (Unless otherwise specified)								
t _{ON}	Turn-ON time	R _L = 10Ω	C _L = 0.1μF	V _{IN} = 0.9V		840		μs
t _{OFF}	Turn-OFF time					16		μs
t _r	V _{OUT} rise time					470		μs
t _f	V _{OUT} fall time					5		μs

Parameter Measurement Information

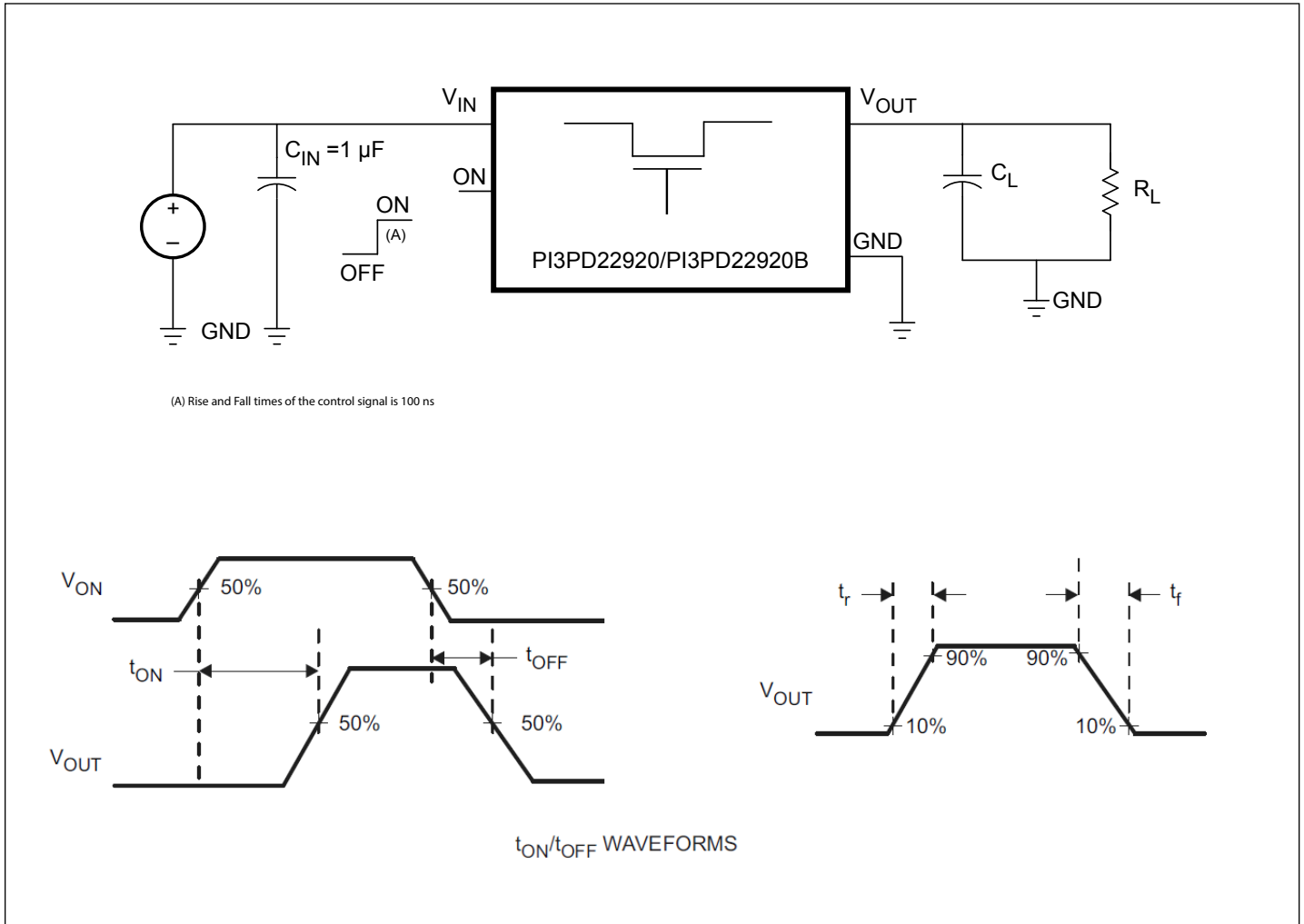

Figure 1. Test Circuit and t_{ON}/t_{OFF} Waveforms

PI3PD22920/PI3PD22920B

**ON-STATE RESISTANCE vs
INPUT VOLTAGE**

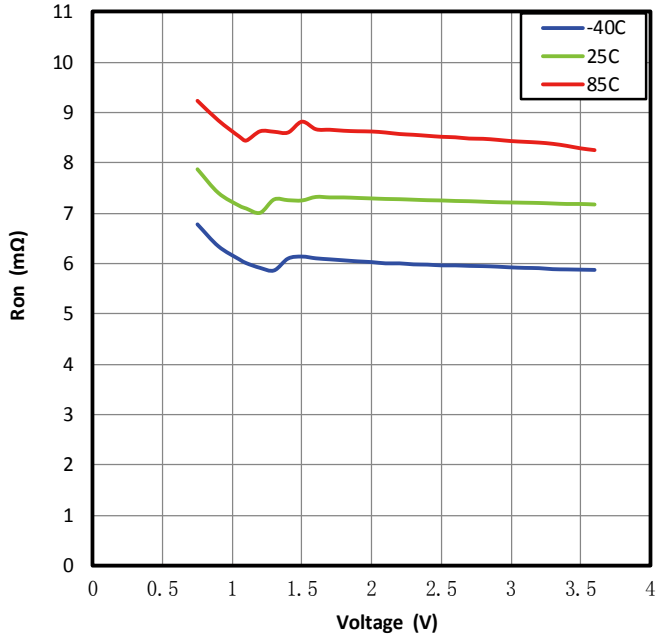

Figure 2.

**ON-STATE RESISTANCE vs
TEMPERATURE**

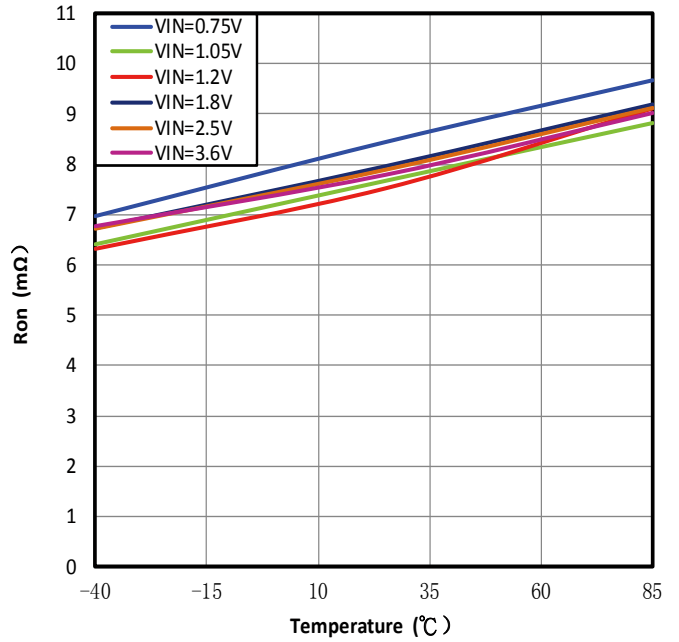

Figure 3.

**INPUT CURRENT, QUIESCENT vs
INPUT VOLTAGE**

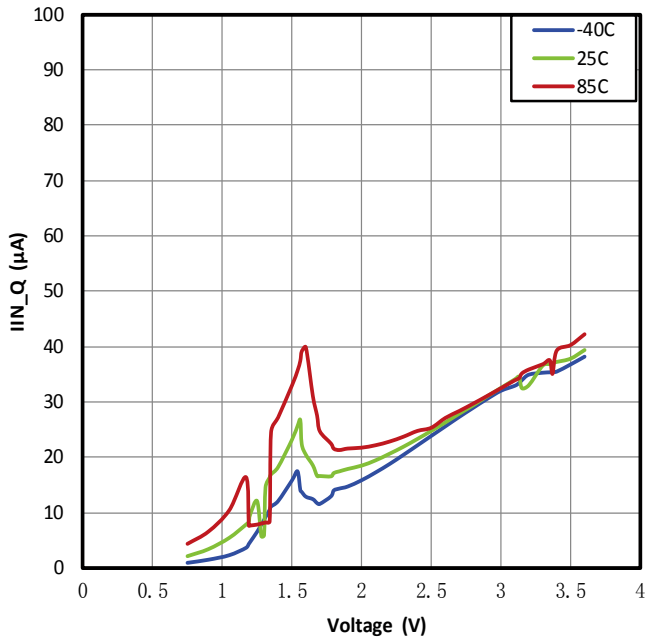

Figure 4.

**INPUT CURRENT, LEAK vs
INPUT VOLTAGE**

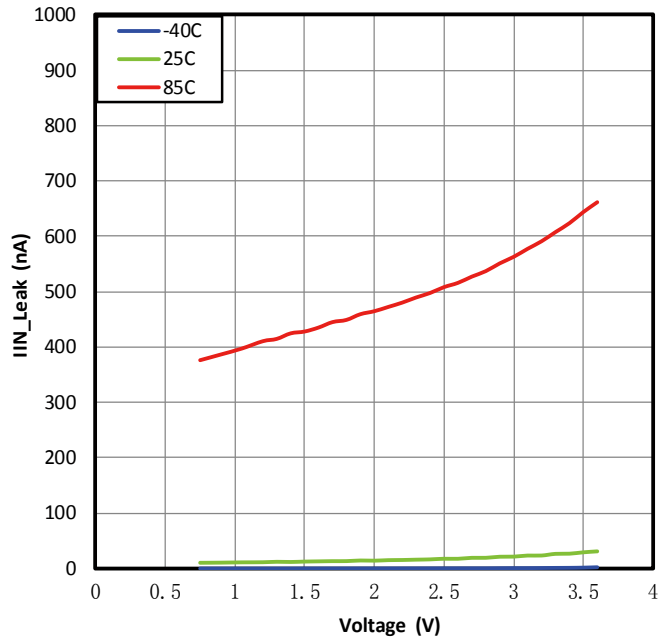

Figure 5.

PI3PD22920/PI3PD22920B

ON INPUT THRESHOLD

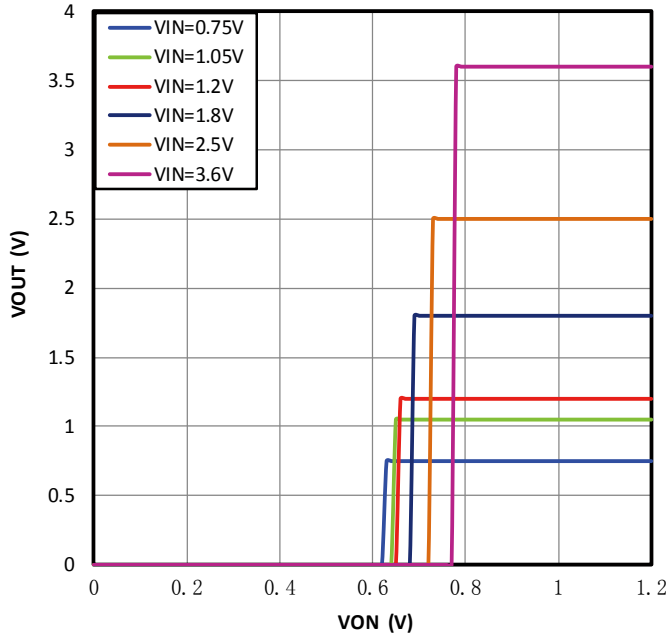

Figure 6.

TURN-ON TIME vs TEMPERATURE

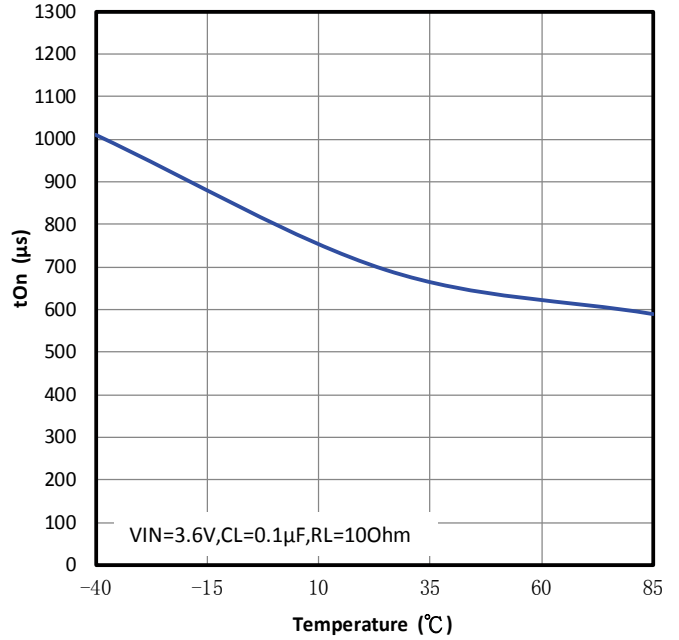

Figure 7.

TURN-OFF TIME vs TEMPERATURE

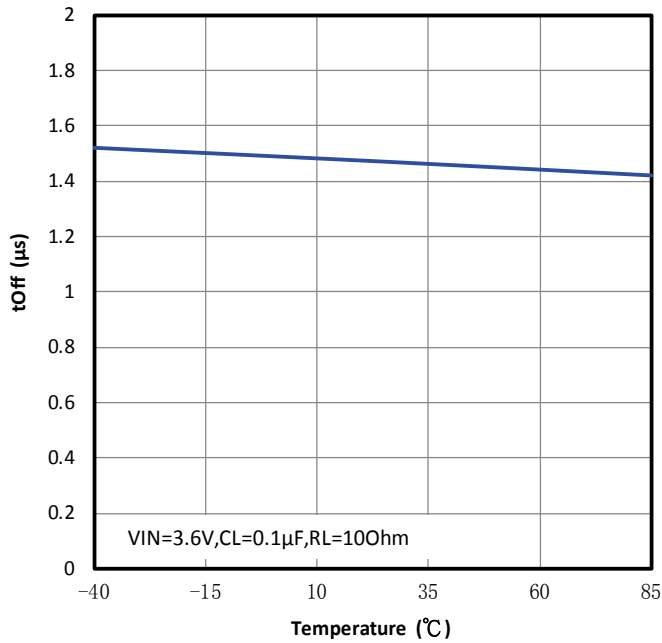

Figure 8.

RISE TIME vs TEMPERATURE

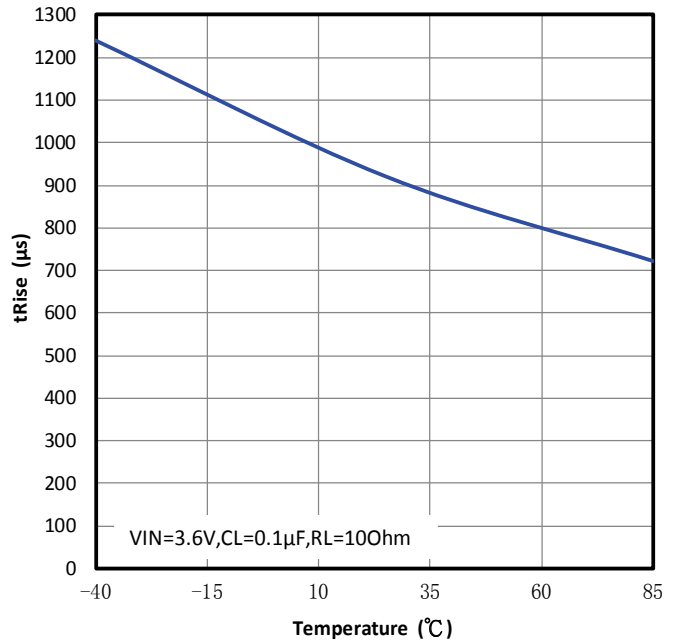

Figure 9.

PI3PD22920/PI3PD22920B

**FALL TIME vs
TEMPERATURE**

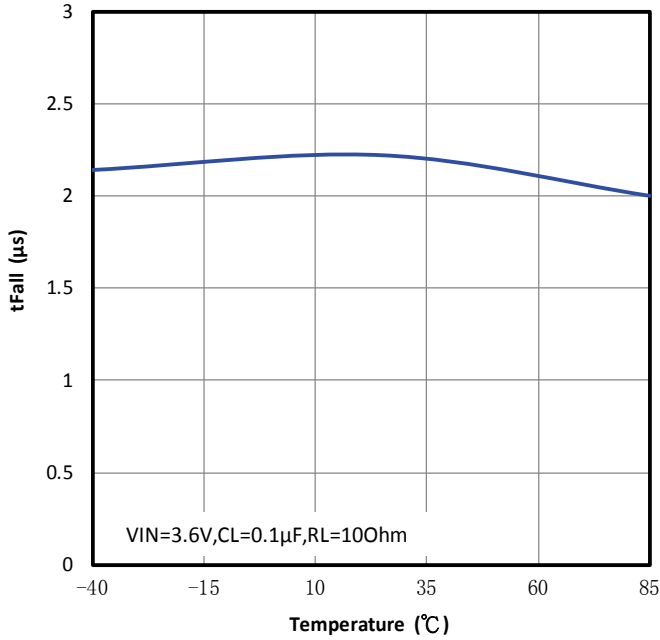

Figure 10.

**TURN-ON TIME vs
TEMPERATURE**

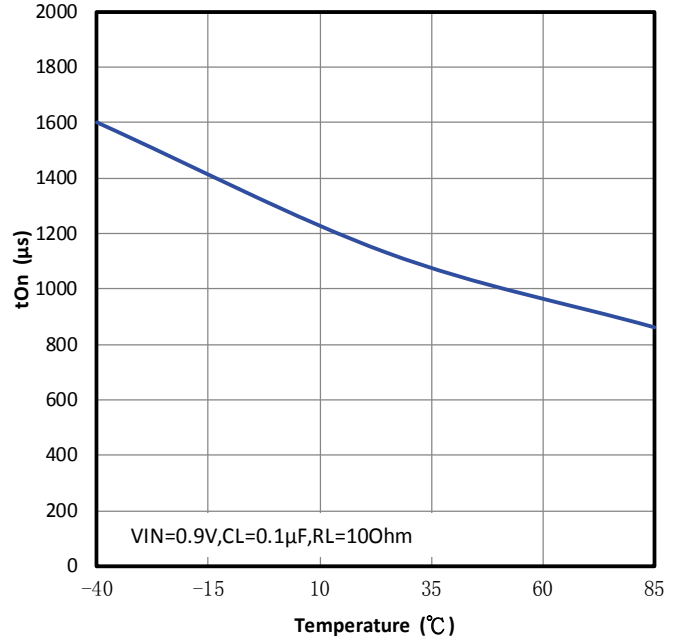

Figure 11.

**TURN-OFF TIME vs
TEMPERATURE**

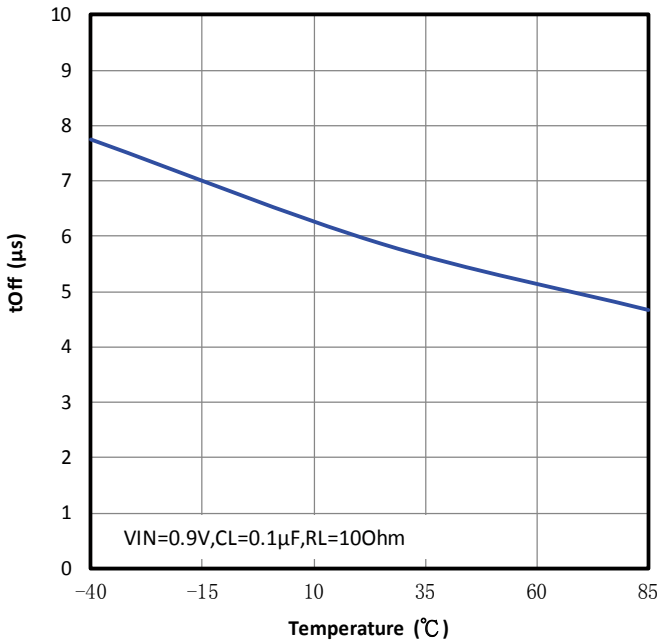

Figure 12.

**RISE TIME vs
TEMPERATURE**

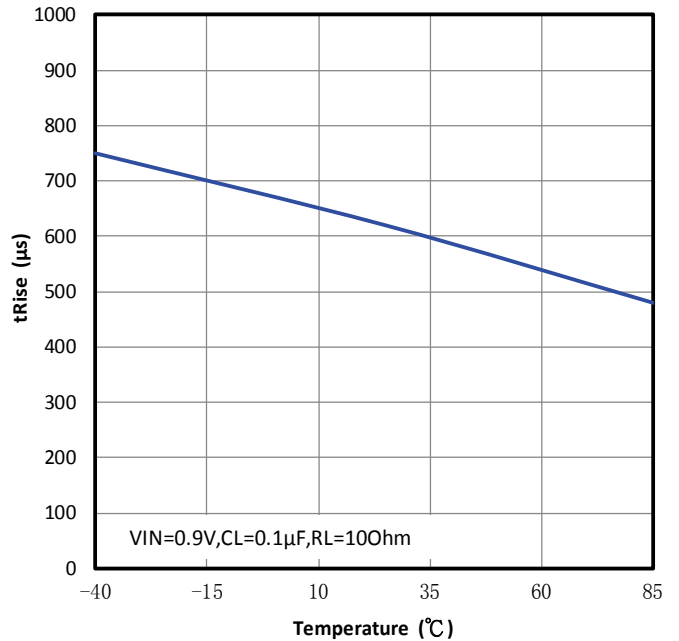

Figure 13.

**FALL TIME vs
TEMPERATURE**

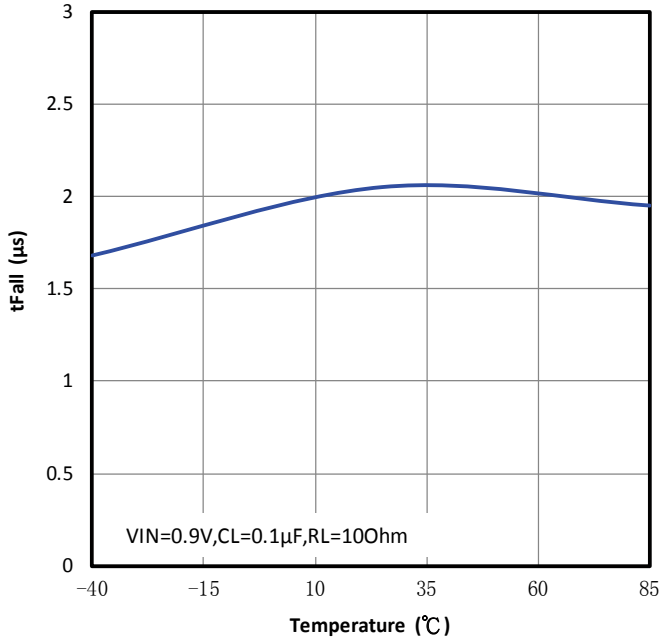

Figure 14.

**RISE TIME vs
INPUT VOLTAGE**

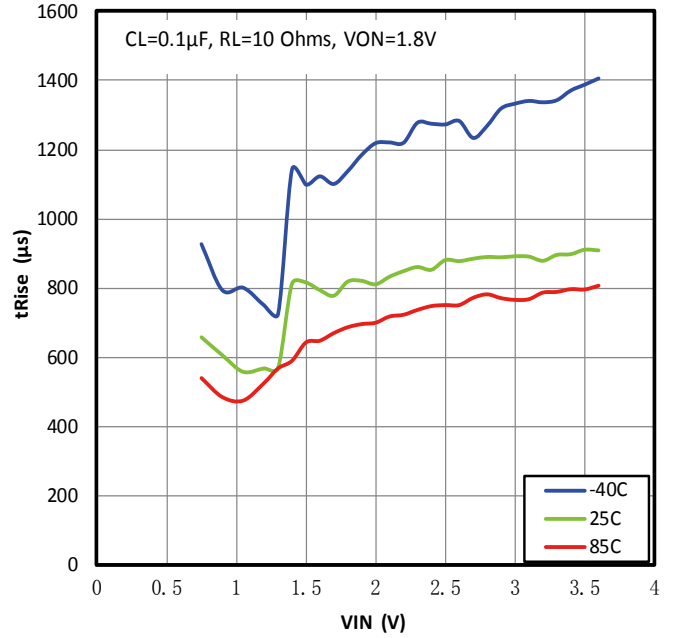

Figure 15.

**RISE TIME vs
INPUT VOLTAGE**

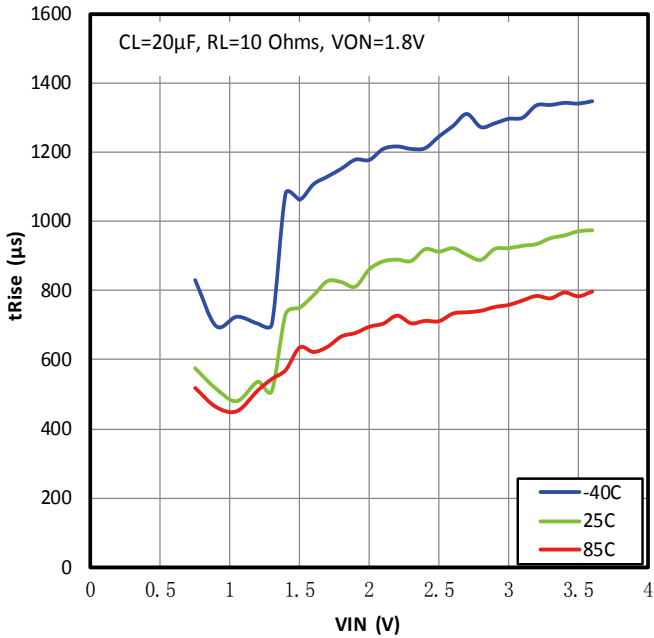

Figure 16.

TURN-ON RESPONSE

$V_{in}=0.9V, T_A=25C, C_{IN}=1\mu F, C_L=0.1\mu F, R_L=10\Omega$

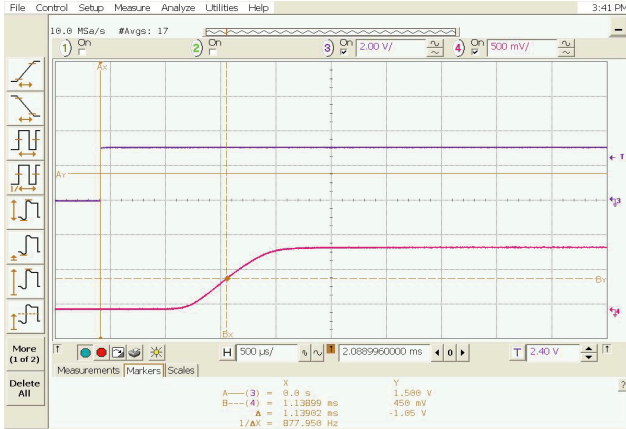

Figure 17.

TURN-OFF RESPONSE

$V_{in}=0.9V, T_A=25C, C_{IN}=1\mu F, C_L=0.1\mu F, R_L=10\Omega$

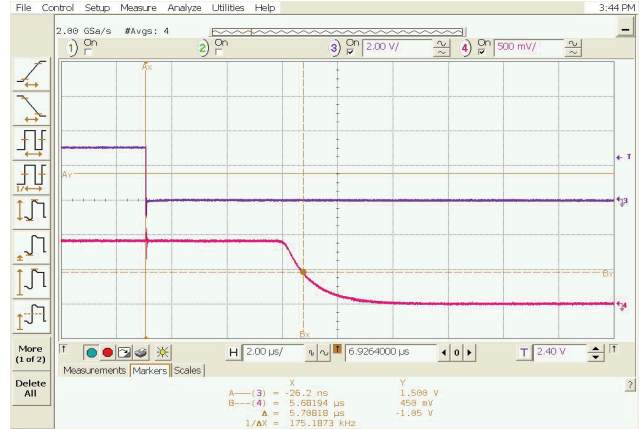

Figure 18.

TURN-ON RESPONSE

$V_{in}=0.9V, T_A=25C, C_{IN}=47\mu F, C_L=20\mu F, R_L=10\Omega$

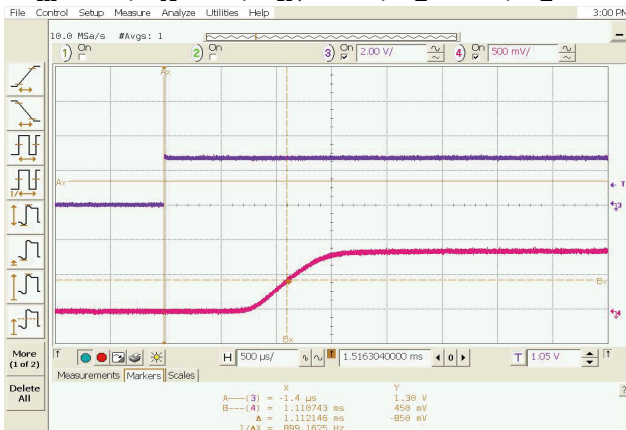

Figure 19.

TURN-OFF RESPONSE

$V_{in}=0.9V, T_A=25C, C_{IN}=47\mu F, C_L=20\mu F, R_L=10\Omega$

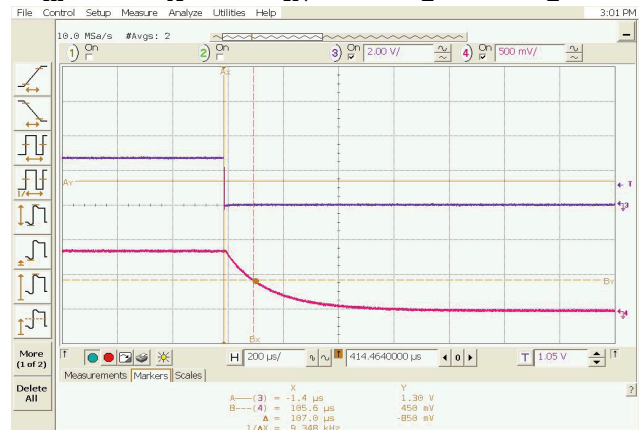

Figure 20.

TURN-ON RESPONSE

$V_{in}=3.6V, T_A=25C, C_{IN}=1\mu F, C_L=0.1\mu F, R_L=10\Omega$

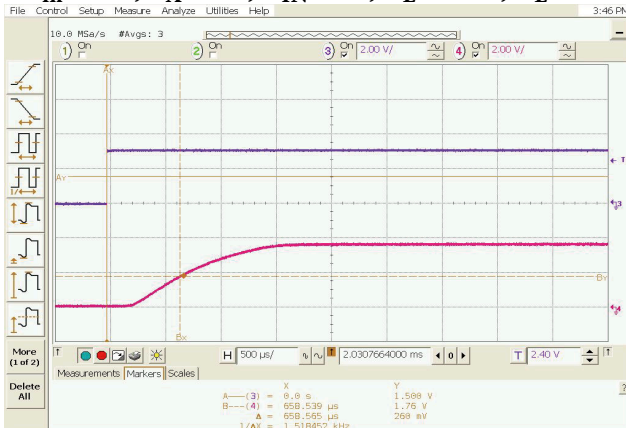

Figure 21.

TURN-OFF RESPONSE

$V_{in}=3.6V, T_A=25C, C_{IN}=1\mu F, C_L=0.1\mu F, R_L=10\Omega$

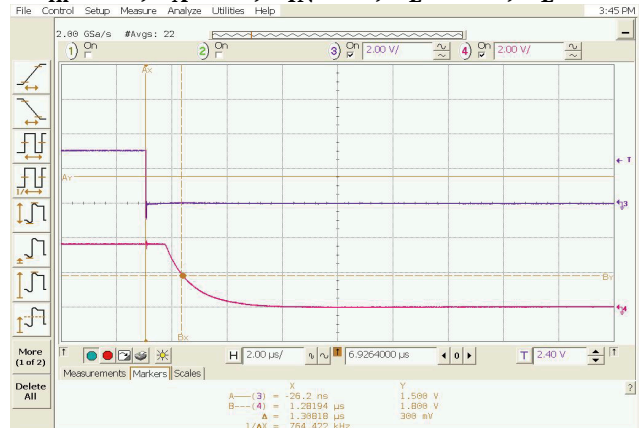

Figure 22.

TURN-ON RESPONSE

$V_{in}=3.6V$, $T_A=25C$, $C_{IN}=47\mu F$, $C_L=20\mu F$, $R_L=10\Omega$

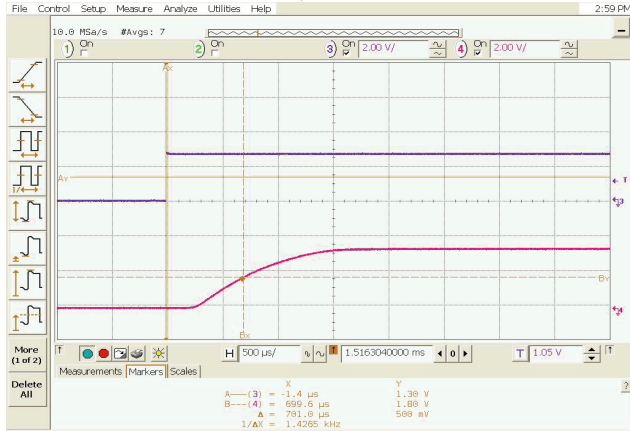

Figure 23.

TURN-OFF RESPONSE

$V_{in}=3.6V$, $T_A=25C$, $C_{IN}=47\mu F$, $C_L=20\mu F$, $R_L=10\Omega$

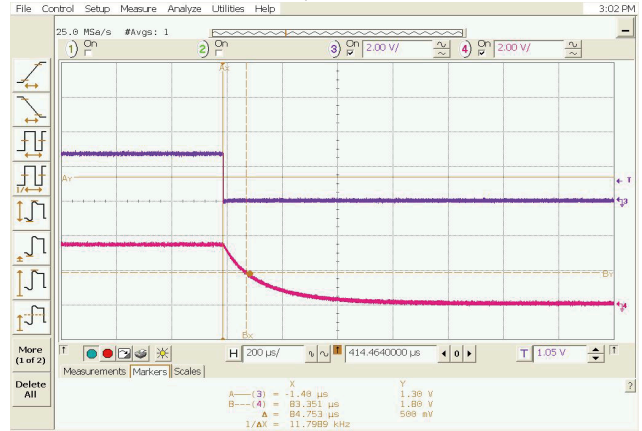
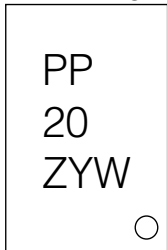

Figure 24.

Part Marking

GB Package



Z: Die Rev

Y: Year

W: Workweek

Packaging Mechanicals: 8-CSP (GB)

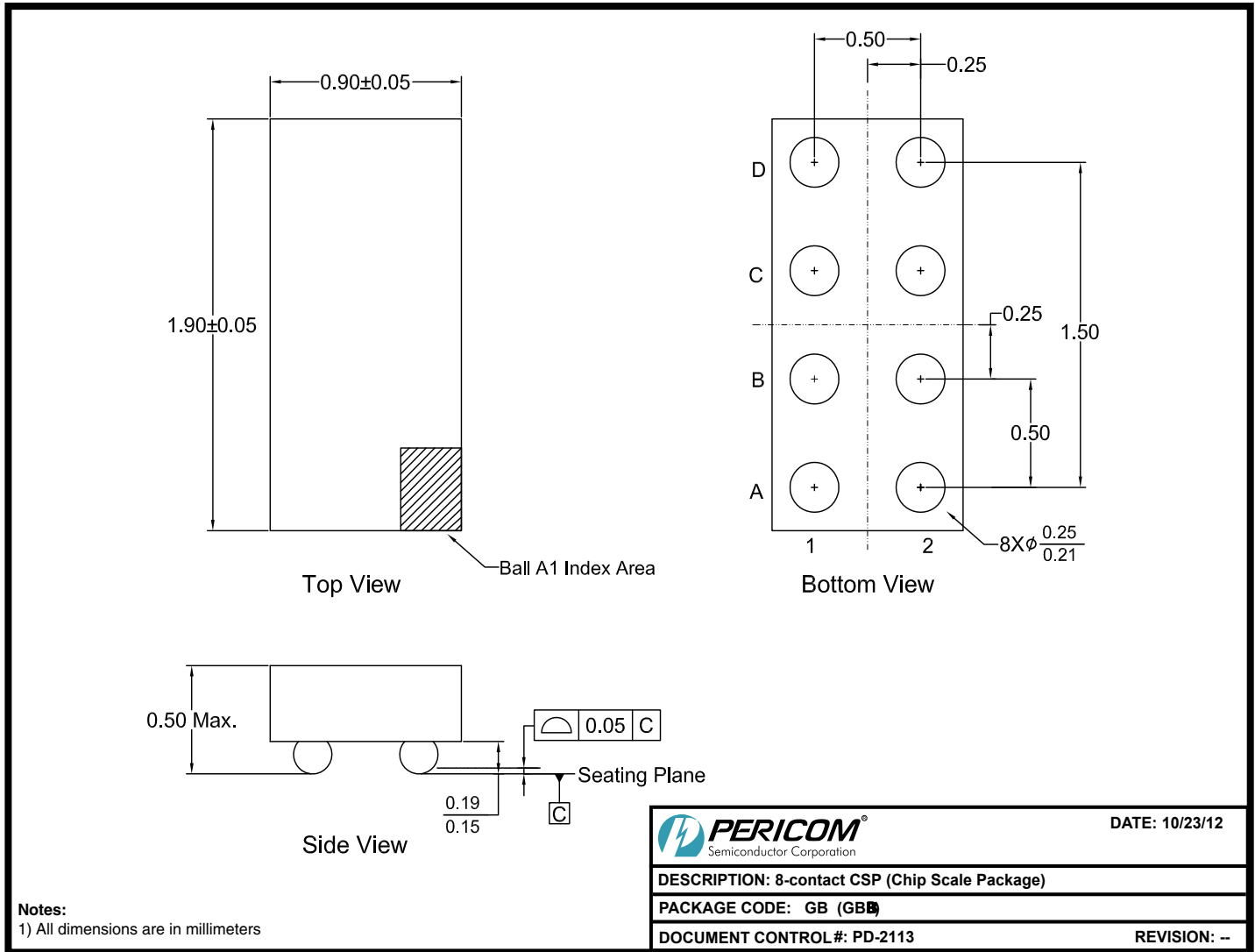

12-0505

For latest package info.

please check: <http://www.diodes.com/design/support/packaging/pericom-packaging/packaging-mechanicals-and-thermal-characteristics/>

Ordering Information

Ordering Code	Package Code	Package Description
PI3PD22920GBEX	GB	8-contact Chip Scale Package (CSP)
PI3PD22920BGBEX	GB	8-contact Chip Scale Package (CSP)

Notes:

1. No purposely added lead. Fully EU Directive 2002/95/EC (RoHS), 2011/65/EU (RoHS 2) & 2015/863/EU (RoHS 3) compliant.
2. See <https://www.diodes.com/quality/lead-free/> for more information about Diodes Incorporated's definitions of Halogen- and Antimony-free, "Green" and Lead-free.
3. Halogen- and Antimony-free "Green" products are defined as those which contain <900ppm bromine, <900ppm chlorine (<1500ppm total Br + Cl) and <1000ppm antimony compounds.
4. E = Pb-free and Green
5. X suffix = Tape/Reel

IMPORTANT NOTICE

DIODES INCORPORATED MAKES NO WARRANTY OF ANY KIND, EXPRESS OR IMPLIED, WITH REGARDS TO THIS DOCUMENT, INCLUDING, BUT NOT LIMITED TO, THE IMPLIED WARRANTIES OF MERCHANTABILITY AND FITNESS FOR A PARTICULAR PURPOSE (AND THEIR EQUIVALENTS UNDER THE LAWS OF ANY JURISDICTION).

Diodes Incorporated and its subsidiaries reserve the right to make modifications, enhancements, improvements, corrections or other changes without further notice to this document and any product described herein. Diodes Incorporated does not assume any liability arising out of the application or use of this document or any product described herein; neither does Diodes Incorporated convey any license under its patent or trademark rights, nor the rights of others. Any Customer or user of this document or products described herein in such applications shall assume all risks of such use and will agree to hold Diodes Incorporated and all the companies whose products are represented on Diodes Incorporated website, harmless against all damages.

Diodes Incorporated does not warrant or accept any liability whatsoever in respect of any products purchased through unauthorized sales channel.

Should Customers purchase or use Diodes Incorporated products for any unintended or unauthorized application, Customers shall indemnify and hold Diodes Incorporated and its representatives harmless against all claims, damages, expenses, and attorney fees arising out of, directly or indirectly, any claim of personal injury or death associated with such unintended or unauthorized application.

Products described herein may be covered by one or more United States, international or foreign patents pending. Product names and markings noted herein may also be covered by one or more United States, international or foreign trademarks.

This document is written in English but may be translated into multiple languages for reference. Only the English version of this document is the final and definitive format released by Diodes Incorporated.

LIFE SUPPORT

Diodes Incorporated products are specifically not authorized for use as critical components in life support devices or systems without the express written approval of the Chief Executive Officer of Diodes Incorporated. As used herein:

A. Life support devices or systems are devices or systems which:

1. are intended to implant into the body, or

2. support or sustain life and whose failure to perform when properly used in accordance with instructions for use provided in the labeling can be reasonably expected to result in significant injury to the user.

B. A critical component is any component in a life support device or system whose failure to perform can be reasonably expected to cause the failure of the life support device or to affect its safety or effectiveness.

Customers represent that they have all necessary expertise in the safety and regulatory ramifications of their life support devices or systems, and acknowledge and agree that they are solely responsible for all legal, regulatory and safety-related requirements concerning their products and any use of Diodes Incorporated products in such safety-critical, life support devices or systems, notwithstanding any devices- or systems-related information or support that may be provided by Diodes Incorporated. Further, Customers must fully indemnify Diodes Incorporated and its representatives against any damages arising out of the use of Diodes Incorporated products in such safety-critical, life support devices or systems.

Copyright © 2016, Diodes Incorporated

www.diodes.com