

## Optocoupler, Phototransistor Output, Single Channel, Half Pitch Mini-Flat Package



22628-1



### FEATURES

- Low profile package (half pitch)
- AC isolation test voltage 3750 V<sub>RMS</sub>
- Low coupling capacitance of typical 0.3 pF
- Current transfer ratio (CTR) selected into groups
- Low temperature coefficient of CTR
- Wide ambient temperature range
- Material categorization: for definitions of compliance please see [www.vishay.com/doc?99912](http://www.vishay.com/doc?99912)



RoHS  
COMPLIANT

### DESCRIPTION

The TCMT110. series consist of a phototransistor optically coupled to a gallium arsenide infrared-emitting diode in a 4 pin package.

The elements are mounted on one leadframe providing a fixed distance between input and output for highest safety requirements.

### APPLICATIONS

- Programmable logic controllers
- Modems
- Answering machines
- General applications

### AGENCY APPROVALS

- UL1577, file no. E76222, double protection
- cUL component acceptance service no. 5A, double protection
- DIN EN 60747-5-5 (VDE 0884-5)
- FIMKO: FI EN 60950-1:2006
- BSI: BS EN60065:2002  
BS EN60950-1:2006
- CQC GB 8898-2011, GB 4943.1-2011 (suitable for installation altitude below 2000 m)

ORDERING INFORMATION										
<div style="display: flex; justify-content: space-around; align-items: center;"> <div style="border: 1px solid black; padding: 2px 5px;">T</div> <div style="border: 1px solid black; padding: 2px 5px;">C</div> <div style="border: 1px solid black; padding: 2px 5px;">M</div> <div style="border: 1px solid black; padding: 2px 5px;">T</div> <div style="border: 1px solid black; padding: 2px 5px;">1</div> <div style="border: 1px solid black; padding: 2px 5px;">1</div> <div style="border: 1px solid black; padding: 2px 5px;">0</div> <div style="border: 1px solid black; padding: 2px 5px;">#</div> </div> <p style="text-align: center;">PART NUMBER</p>										
AGENCY CERTIFIED/ PACKAGE	CTR (%)									
	5 mA	10 mA				5 mA				
UL, cUL, FIMKO, BSI, VDE	50 to 600	40 to 80	63 to 125	100 to 200	160 to 320	50 to 150	100 to 300	80 to 160	130 to 260	200 to 400
SSOP-4	TCMT1100	TCMT1101	TCMT1102	TCMT1103	TCMT1104	TCMT1105	TCMT1106	TCMT1107, TCMT1107T3 <sup>(1)</sup>	TCMT1108	TCMT1109

### Notes

- Available only on tape and reel
- <sup>(1)</sup> Product is rotated 180° in tape and reel cavity



ABSOLUTE MAXIMUM RATINGS (T <sub>amb</sub> = 25 °C, unless otherwise specified)				
PARAMETER	TEST CONDITION	SYMBOL	VALUE	UNIT
<b>INPUT</b>				
Reverse voltage		V <sub>R</sub>	6	V
Forward current		I <sub>F</sub>	60	mA
Forward surge current	t <sub>p</sub> ≤ 10 μs	I <sub>FSM</sub>	1.5	A
Power dissipation		P <sub>diss</sub>	100	mW
Junction temperature		T <sub>j</sub>	125	°C
<b>OUTPUT</b>				
Collector emitter voltage		V <sub>CEO</sub>	70	V
Emitter collector voltage		V <sub>ECO</sub>	7	V
Collector current		I <sub>C</sub>	50	mA
Collector peak current	t <sub>p</sub> /T = 0.5, t <sub>p</sub> ≤ 10 ms	I <sub>CM</sub>	100	mA
Power dissipation		P <sub>diss</sub>	150	mW
Junction temperature		T <sub>j</sub>	125	°C
<b>COUPLER</b>				
AC isolation test voltage (RMS)	Related to standard climate 23/50 DIN 50014	V <sub>ISO</sub>	3750	V <sub>RMS</sub>
Total power dissipation		P <sub>tot</sub>	250	mW
Operating ambient temperature range		T <sub>amb</sub>	-40 to +100	°C
Storage temperature range		T <sub>stg</sub>	-40 to +125	°C
Soldering temperature <sup>(1)</sup>		T <sub>slid</sub>	260	°C

**Notes**

- Stresses in excess of the absolute maximum ratings can cause permanent damage to the device. Functional operation of the device is not implied at these or any other conditions in excess of those given in the operational sections of this document. Exposure to absolute maximum ratings for extended periods of the time can adversely affect reliability
- <sup>(1)</sup> Refer to reflow profile for soldering conditions for surface mounted devices. Also refer to “Assembly Instructions” ([www.vishay.com/doc?80054](http://www.vishay.com/doc?80054))

ELECTRICAL CHARACTERISTICS (T <sub>amb</sub> = 25 °C, unless otherwise specified)						
PARAMETER	TEST CONDITION	SYMBOL	MIN.	TYP.	MAX.	UNIT
<b>INPUT</b>						
Forward voltage	I <sub>F</sub> = 50 mA	V <sub>F</sub>	-	1.35	1.6	V
Junction capacitance	V <sub>R</sub> = 0, f = 1 MHz	C <sub>j</sub>	-	8		pF
<b>OUTPUT</b>						
Collector emitter voltage	I <sub>C</sub> = 100 μA	V <sub>CEO</sub>	70	-	-	V
Emitter collector voltage	I <sub>E</sub> = 100 μA	V <sub>ECO</sub>	7	-	-	V
Collector dark current	V <sub>CE</sub> = 20 V, I <sub>F</sub> = 0 A	I <sub>CEO</sub>	-	-	100	nA
<b>COUPLER</b>						
Collector emitter saturation voltage	I <sub>F</sub> = 10 mA, I <sub>C</sub> = 1 mA	V <sub>CEsat</sub>	-	-	0.3	V
Cut-off frequency	V <sub>CE</sub> = 5 V, I <sub>F</sub> = 10 mA, R <sub>L</sub> = 100 Ω	f <sub>c</sub>	-	100	-	kHz
Coupling capacitance	f = 1 MHz	C <sub>k</sub>	-	0.3	-	pF

**Note**

- Minimum and maximum values are testing requirements. Typical values are characteristics of the device and are the result of engineering evaluation. Typical values are for information only and are not part of the testing requirements

CURRENT TRANSFER RATIO ( $T_{amb} = 25^\circ\text{C}$ , unless otherwise specified)							
PARAMETER	TEST CONDITION	PART	SYMBOL	MIN.	TYP.	MAX.	UNIT
$I_C/I_F$	$V_{CE} = 5\text{ V}, I_F = 5\text{ mA}$	TCMT1100	CTR	50	-	600	%
	$V_{CE} = 5\text{ V}, I_F = 10\text{ mA}$	TCMT1101	CTR	40	-	80	%
		TCMT1102	CTR	63	-	125	%
		TCMT1103	CTR	100	-	200	%
		TCMT1104	CTR	160	-	320	%
	$V_{CE} = 5\text{ V}, I_F = 5\text{ mA}$	TCMT1105	CTR	50	-	150	%
		TCMT1106	CTR	100	-	300	%
		TCMT1107	CTR	80	-	160	%
		TCMT1108	CTR	130	-	260	%
TCMT1109		CTR	200	-	400	%	

SWITCHING CHARACTERISTICS ( $T_{amb} = 25^\circ\text{C}$ , unless otherwise specified)							
PARAMETER	TEST CONDITION	SYMBOL	MIN.	TYP.	MAX.	UNIT	
Delay time	$V_S = 5\text{ V}, I_C = 2\text{ mA}, R_L = 100\ \Omega$ , (see figure 1)	$t_d$	-	4.0	-	$\mu\text{s}$	
Rise time	$V_S = 5\text{ V}, I_C = 2\text{ mA}, R_L = 100\ \Omega$ , (see figure 1)	$t_r$	-	5.5	-	$\mu\text{s}$	
Fall time	$V_S = 5\text{ V}, I_C = 2\text{ mA}, R_L = 100\ \Omega$ , (see figure 1)	$t_f$	-	7.0	-	$\mu\text{s}$	
Storage time	$V_S = 5\text{ V}, I_C = 2\text{ mA}, R_L = 100\ \Omega$ , (see figure 1)	$t_s$	-	1.5	-	$\mu\text{s}$	
Turn-on time	$V_S = 5\text{ V}, I_C = 2\text{ mA}, R_L = 100\ \Omega$ , (see figure 1)	$t_{on}$	-	9.5	-	$\mu\text{s}$	
Turn-off time	$V_S = 5\text{ V}, I_C = 2\text{ mA}, R_L = 100\ \Omega$ , (see figure 1)	$t_{off}$	-	8.5	-	$\mu\text{s}$	
Turn-on time	$V_S = 5\text{ V}, I_F = 10\text{ mA}, R_L = 1\text{ k}\Omega$ , (see figure 2)	$t_{on}$	-	3.0	-	$\mu\text{s}$	
Turn-off time	$V_S = 5\text{ V}, I_F = 10\text{ mA}, R_L = 1\text{ k}\Omega$ , (see figure 2)	$t_{off}$	-	20.0	-	$\mu\text{s}$	



95 10804  
Fig. 1 - Test Circuit, Non-Saturated Operation

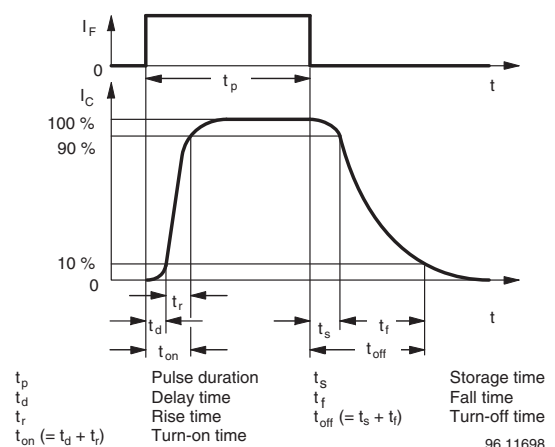
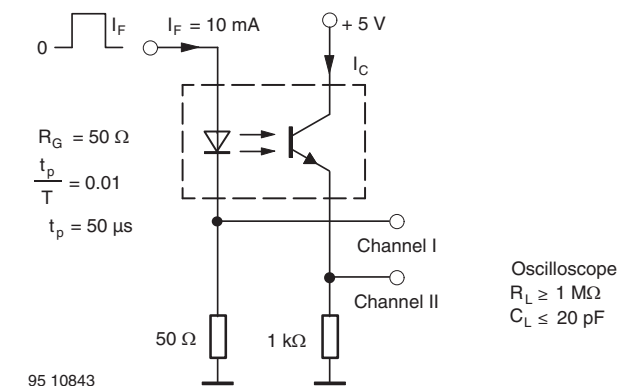

Fig. 3 - Switching Times



95 10843  
Fig. 2 - Test Circuit, Saturated Operation

SAFETY AND INSULATION RATINGS				
PARAMETER	TEST CONDITION	SYMBOL	VALUE	UNIT
Climatic classification	According to IEC 68 part 1		40 / 110 / 21	
Pollution degree	According to DIN VDE 0109		2	
Comparative tracking index	Insulation group IIIa	CTI	175	
Maximum rated withstanding isolation voltage	According to UL1577, t = 1 min	V <sub>ISO</sub>	3750	V <sub>RMS</sub>
Maximum transient isolation voltage	According to DIN EN 60747-5-5	V <sub>IOTM</sub>	6000	V <sub>peak</sub>
Maximum repetitive peak isolation voltage	According to DIN EN 60747-5-5	V <sub>IORM</sub>	707	V <sub>peak</sub>
Isolation resistance	T <sub>amb</sub> = 25 °C, V <sub>IO</sub> = 500 V	R <sub>IO</sub>	≥ 10 <sup>12</sup>	Ω
	T <sub>amb</sub> = 100 °C, V <sub>IO</sub> = 500 V		≥ 10 <sup>11</sup>	
	T <sub>amb</sub> = T <sub>S</sub> , V <sub>IO</sub> = 500 V		≥ 10 <sup>9</sup>	
Output safety power		P <sub>SO</sub>	350	mW
Input safety current		I <sub>SI</sub>	150	mA
Input safety temperature		T <sub>S</sub>	175	°C
Creepage distance			≥ 5	mm
Clearance distance			≥ 5	mm
Insulation thickness		DTI	≥ 0.4	mm
Input to output test voltage, method B	V <sub>IORM</sub> × 1.875 = V <sub>PR</sub> , 100 % production test with t <sub>M</sub> = 1 s, partial discharge < 5 pC	V <sub>PR</sub>	1326	V <sub>peak</sub>
Input to output test voltage, method A	V <sub>IORM</sub> × 1.6 = V <sub>PR</sub> , 100 % sample test with t <sub>M</sub> = 10 s, partial discharge < 5 pC	V <sub>PR</sub>	1132	V <sub>peak</sub>

### TYPICAL CHARACTERISTICS (T<sub>amb</sub> = 25 °C, unless otherwise specified)



Fig. 4 - Total Power Dissipation vs. Ambient Temperature



Fig. 5 - Forward Voltage vs. Forward Current

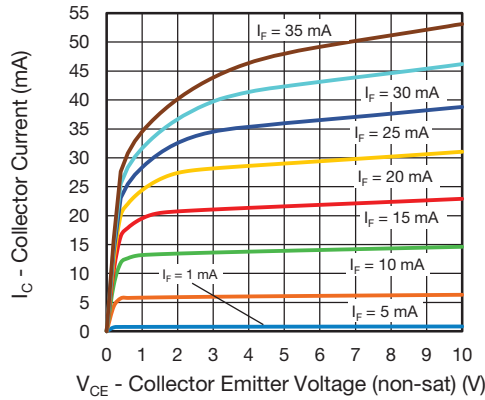

Fig. 6 - Collector Current vs. Collector Emitter Voltage

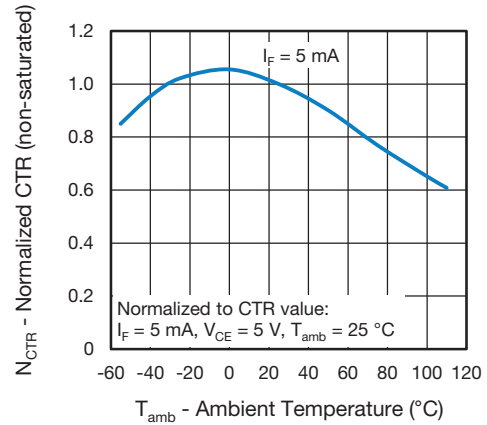

Fig. 9 - Normalized Current Transfer Ratio (non-saturated) vs. Ambient Temperature

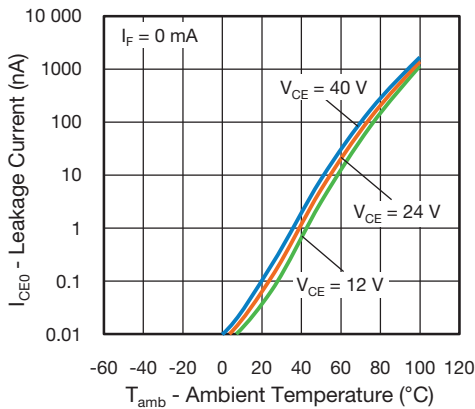

Fig. 7 - Leakage Current vs. Ambient Temperature

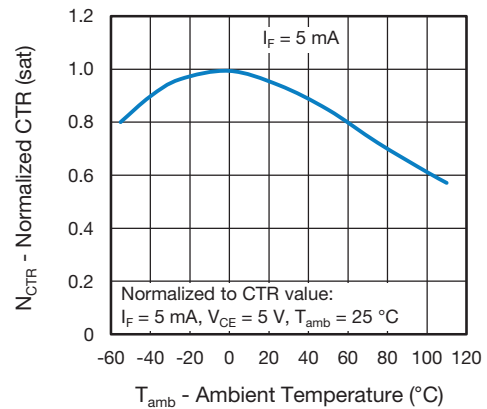

Fig. 10 - Normalized Current Transfer Ratio (saturated) vs. Ambient Temperature

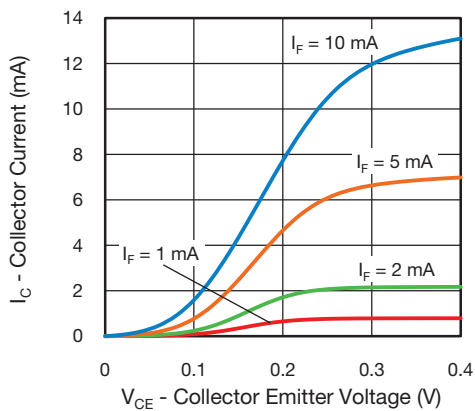

Fig. 8 - Collector Current vs. Collector Emitter Voltage

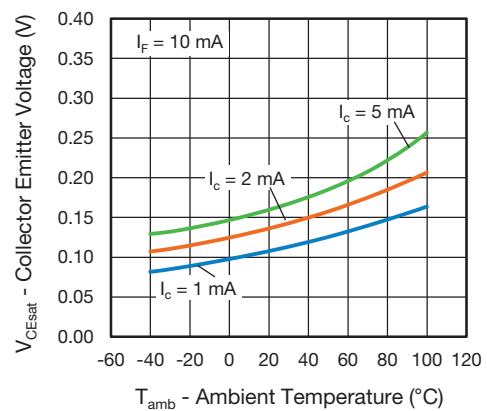

Fig. 11 - Collector Emitter Voltage vs. Ambient Temperature

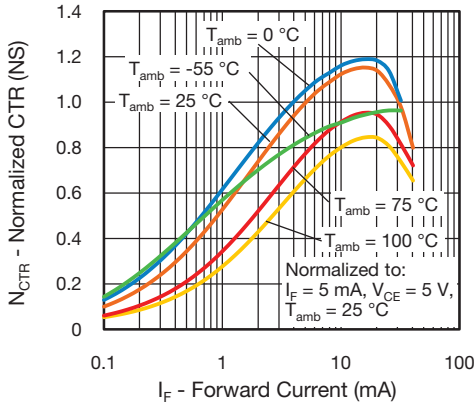

Fig. 12 - Normalized CTR (non-saturated) vs. Forward Current



Fig. 15 -  $F_{CTR}$  vs. Collector Current

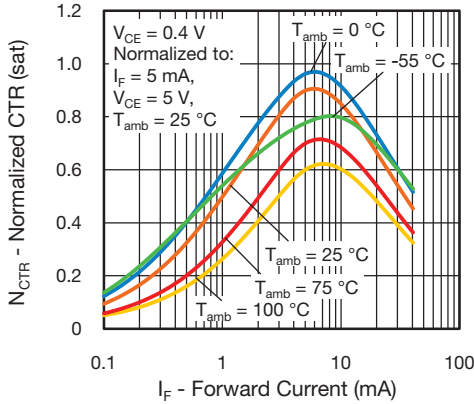

Fig. 13 - Normalized CTR (saturated) vs. Forward Current

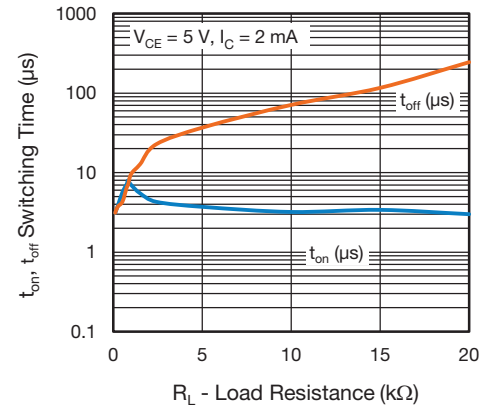

Fig. 16 - Switching Time vs. Load Resistance

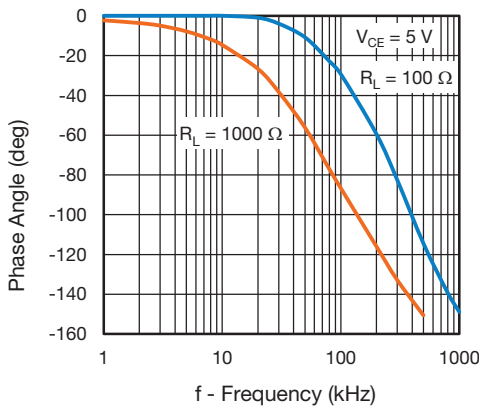
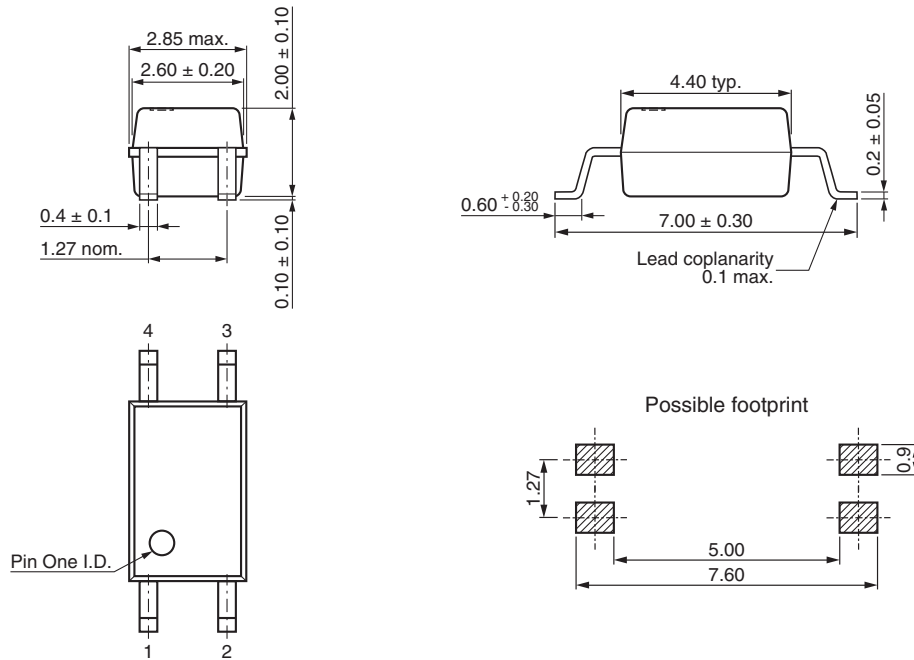

Fig. 14 -  $F_{CTR}$  vs. Phase Angle



**PACKAGE DIMENSIONS** in millimeters



**PACKAGE MARKING** (example)

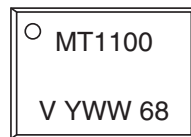

**TAPE AND REEL PACKAGING** in millimeters

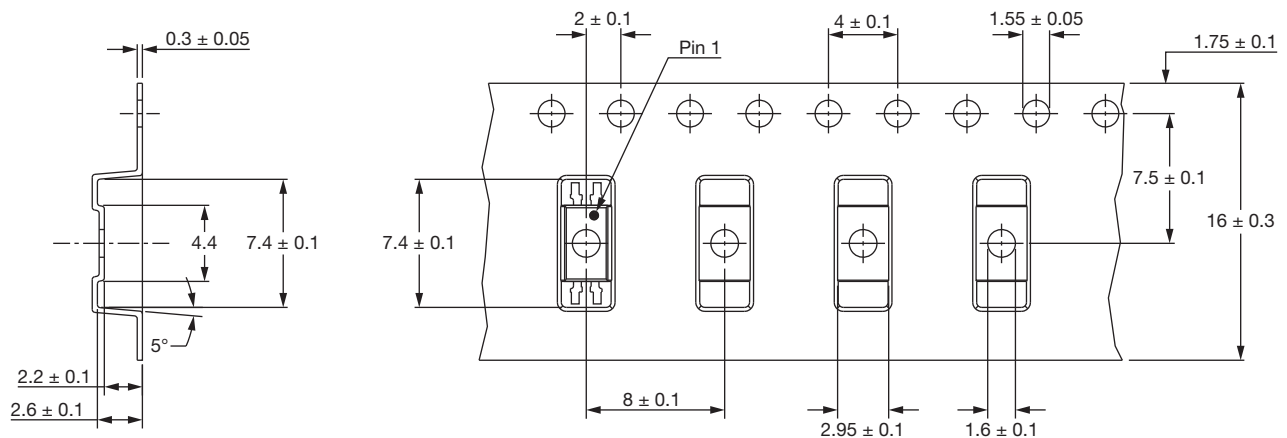
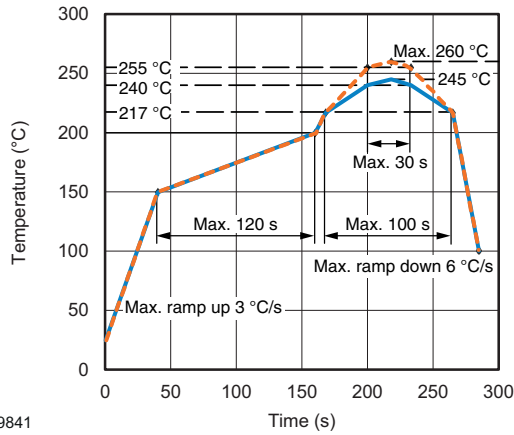

Fig. 17



## SOLDER PROFILES



19841

Fig. 18 - Lead (Pb)-free Reflow Solder Profile According to J-STD-020 for SMD Devices

## HANDLING AND STORAGE CONDITIONS

ESD level: HBM class 2

Floor life: unlimited

Conditions:  $T_{amb} < 30\text{ °C}$ , RH < 85 %

Moisture sensitivity level 1, according to J-STD-020





## **Disclaimer**

ALL PRODUCT, PRODUCT SPECIFICATIONS AND DATA ARE SUBJECT TO CHANGE WITHOUT NOTICE TO IMPROVE RELIABILITY, FUNCTION OR DESIGN OR OTHERWISE.

Vishay Intertechnology, Inc., its affiliates, agents, and employees, and all persons acting on its or their behalf (collectively, "Vishay"), disclaim any and all liability for any errors, inaccuracies or incompleteness contained in any datasheet or in any other disclosure relating to any product.

Vishay makes no warranty, representation or guarantee regarding the suitability of the products for any particular purpose or the continuing production of any product. To the maximum extent permitted by applicable law, Vishay disclaims (i) any and all liability arising out of the application or use of any product, (ii) any and all liability, including without limitation special, consequential or incidental damages, and (iii) any and all implied warranties, including warranties of fitness for particular purpose, non-infringement and merchantability.

Statements regarding the suitability of products for certain types of applications are based on Vishay's knowledge of typical requirements that are often placed on Vishay products in generic applications. Such statements are not binding statements about the suitability of products for a particular application. It is the customer's responsibility to validate that a particular product with the properties described in the product specification is suitable for use in a particular application. Parameters provided in datasheets and / or specifications may vary in different applications and performance may vary over time. All operating parameters, including typical parameters, must be validated for each customer application by the customer's technical experts. Product specifications do not expand or otherwise modify Vishay's terms and conditions of purchase, including but not limited to the warranty expressed therein.

Except as expressly indicated in writing, Vishay products are not designed for use in medical, life-saving, or life-sustaining applications or for any other application in which the failure of the Vishay product could result in personal injury or death. Customers using or selling Vishay products not expressly indicated for use in such applications do so at their own risk. Please contact authorized Vishay personnel to obtain written terms and conditions regarding products designed for such applications.

No license, express or implied, by estoppel or otherwise, to any intellectual property rights is granted by this document or by any conduct of Vishay. Product names and markings noted herein may be trademarks of their respective owners.